

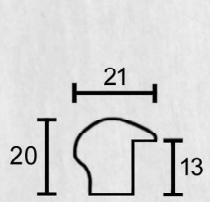

Provasi Cornici

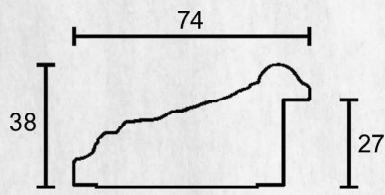

Art. 976



Art. 686

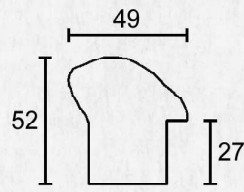

Art. 906/30

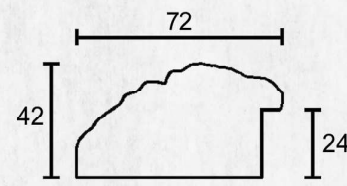

Art. 845

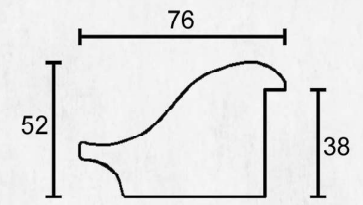

Art. 819



976

686

906/30

845

819

822

820

821

796

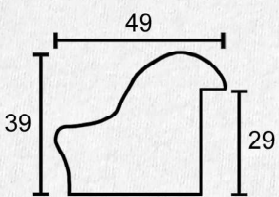

Art. 822

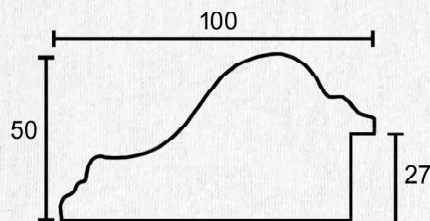

Art. 820

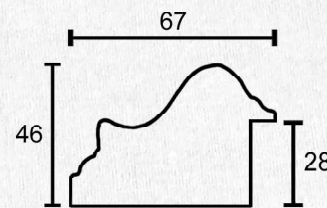

Art. 821

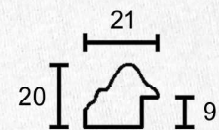

Art. 796

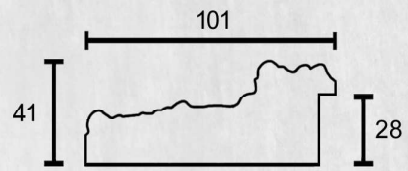

Art. 699

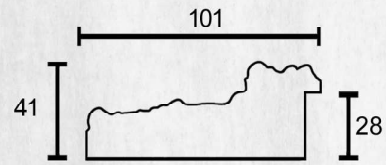

Art. 799

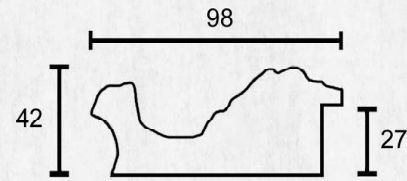

Art. 1899

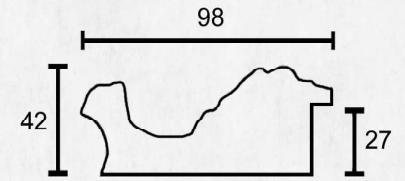

Art. 899



699

799

1899

899

897

898

1898

1897

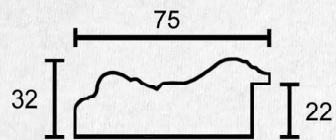

Art. 897

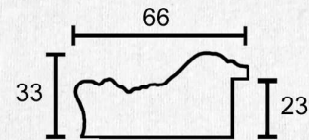

Art. 898

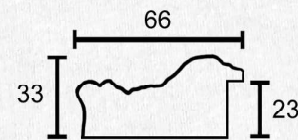

Art. 1898

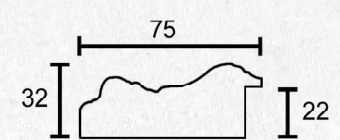

Art. 1897

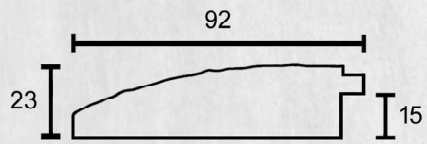

Art. 937

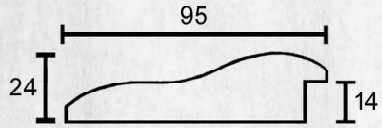

Art. 960

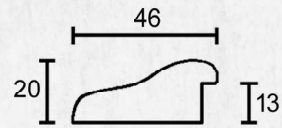

Art. 961

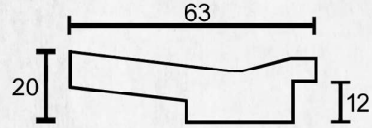

Art. 963

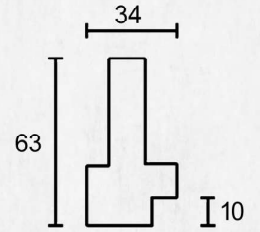

Art. 42065



937

960

961

963

42065

42060

42070

981

909 LIST. B.

909 LIST.

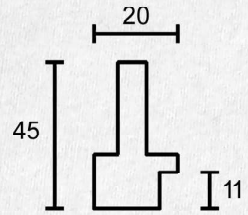

Art. 42060

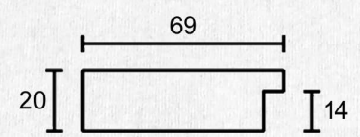

Art. 42070

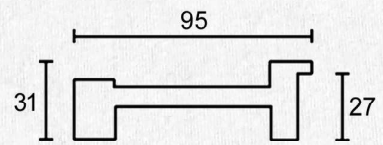

Art. 981

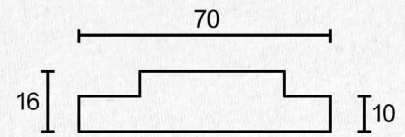

Art. 909 LIST. B.

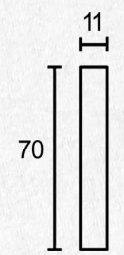

Art. 909 LIST.

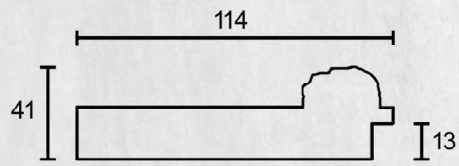

Art. 1672

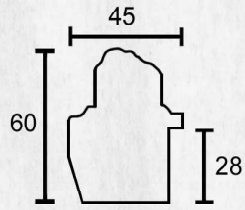

Art. 672 ALTA

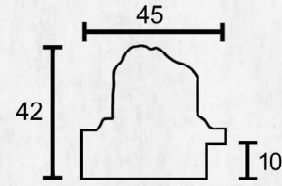

Art. 672

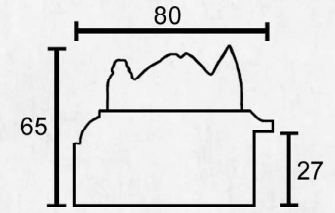

Art. 671 ALTA



1672



672 ALTA



672



671 ALTA



671



571



572



846

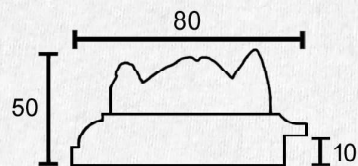

Art. 671

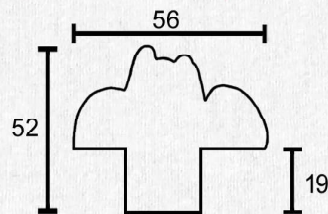

Art. 571

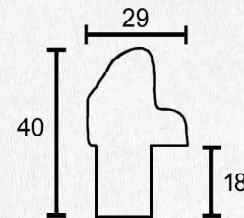

Art. 572

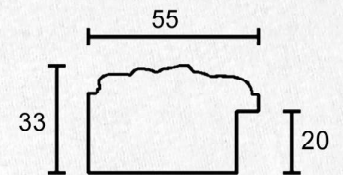

Art. 846

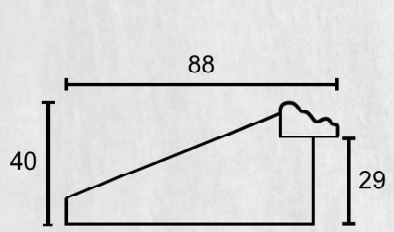

Art. 280

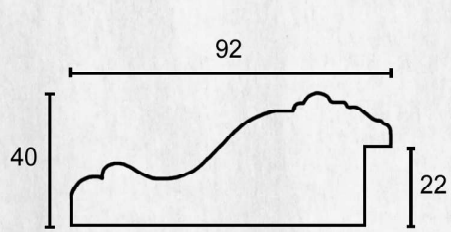

Art. 425

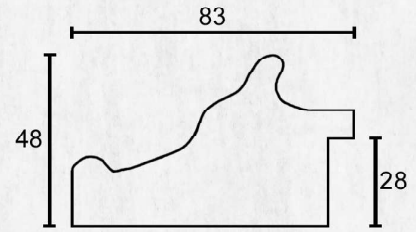

Art. 656

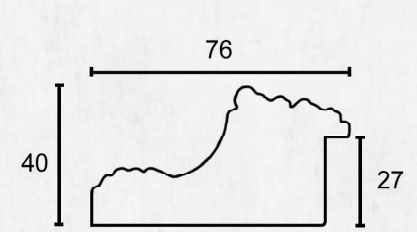

Art. 270



280

425

656

270

780

655

745

719

718

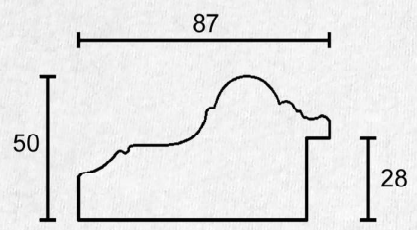

Art. 780

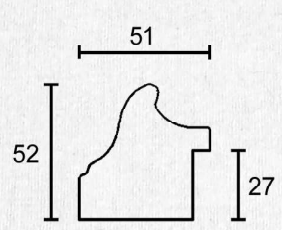

Art. 655

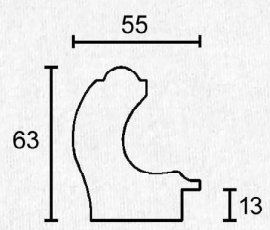

Art. 745

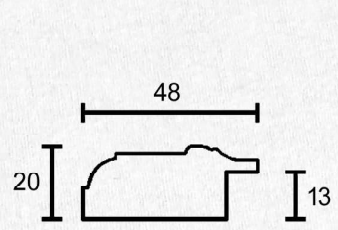

Art. 719

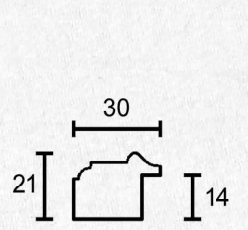

Art. 718

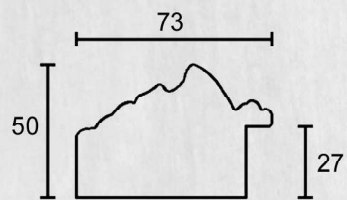

Art. 800

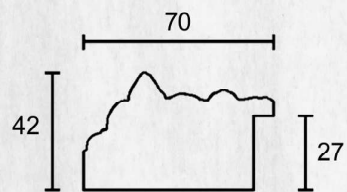

Art. 685

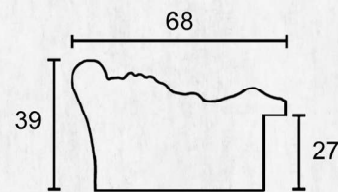

Art. 660

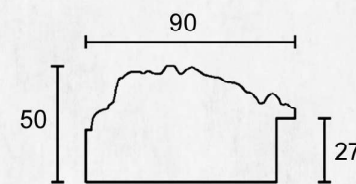

Art. 985



800



685



660



985



669



1080



687



1220

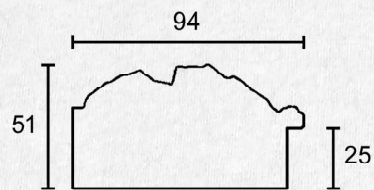

Art. 669

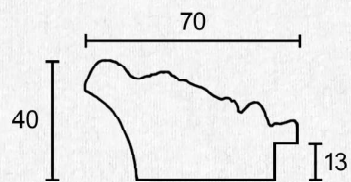

Art. 1080

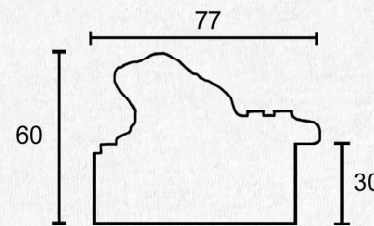

Art. 687

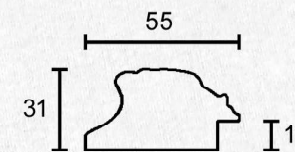

Art. 1220

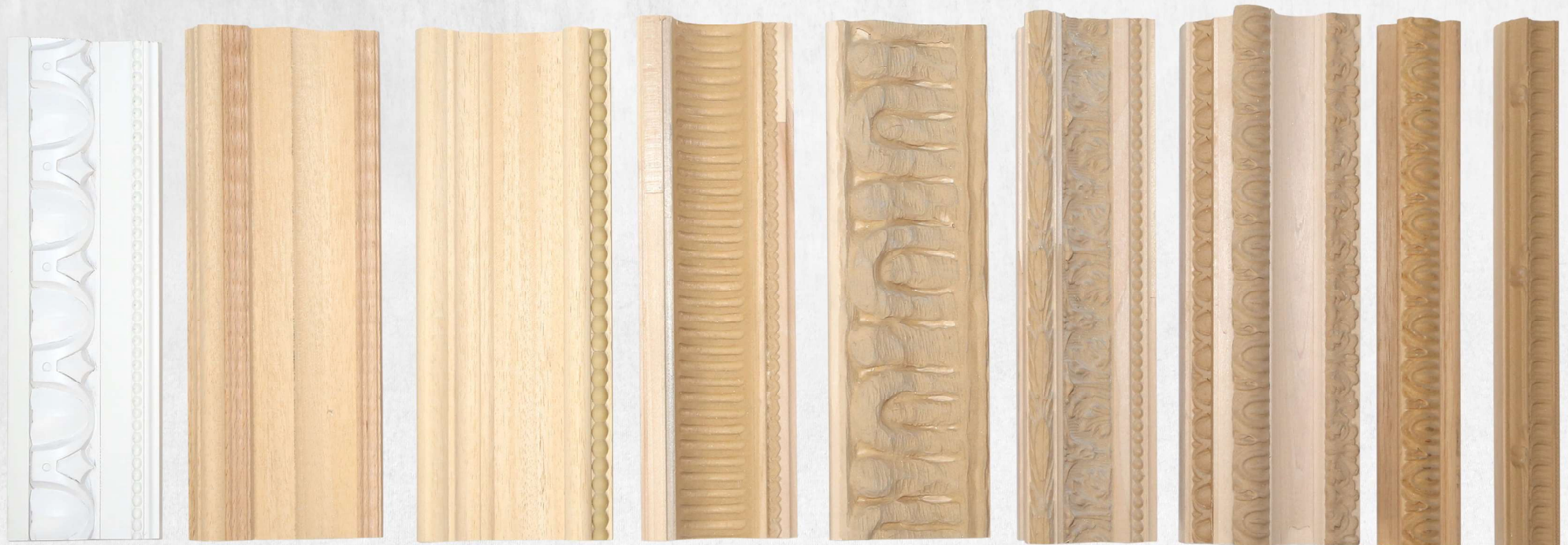
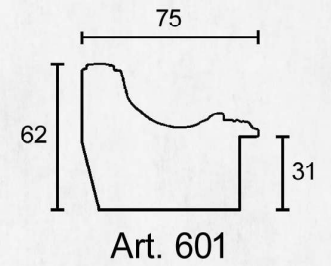
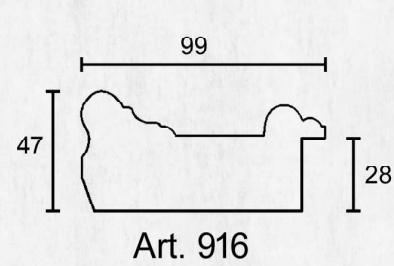
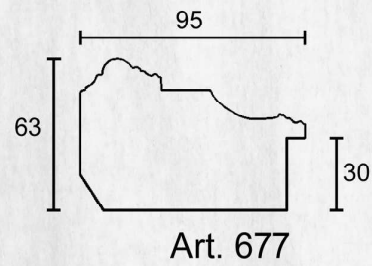
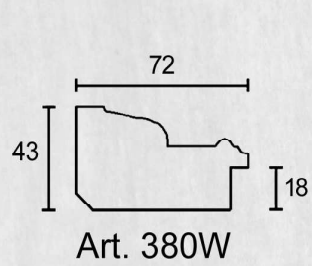

380 W

677

916

601

835

871

662

663

628

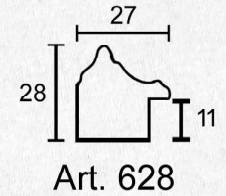
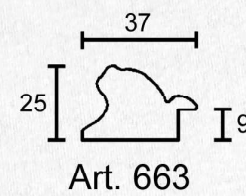
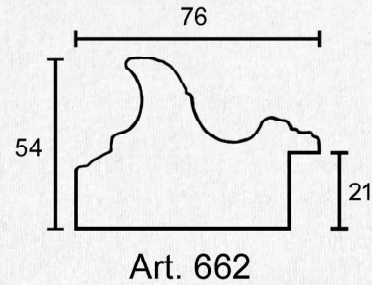
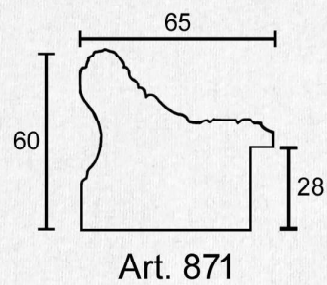
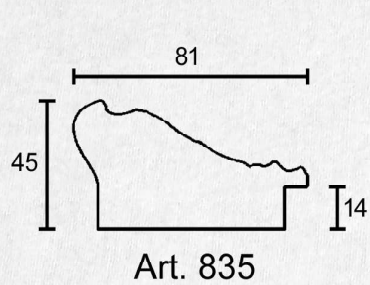

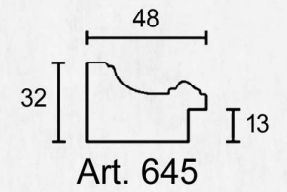
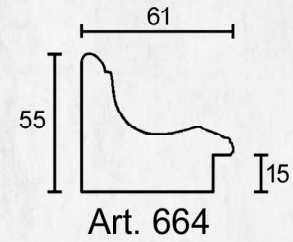
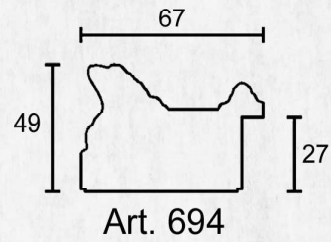
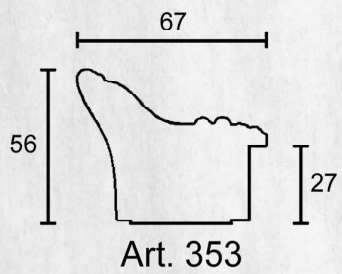
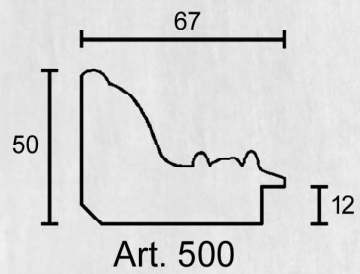

500

353

694

664

645

744

535

618

75/30
GRECA

743

743 P

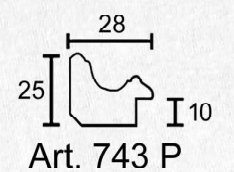
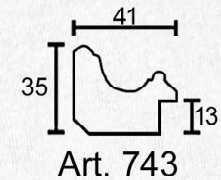
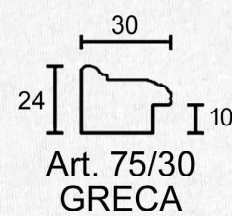
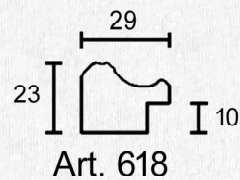
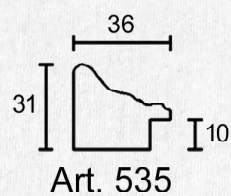
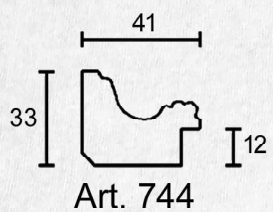

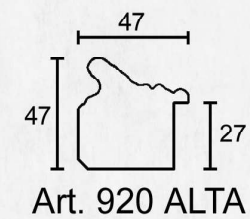
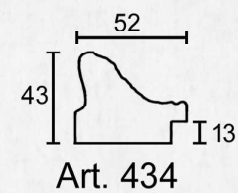
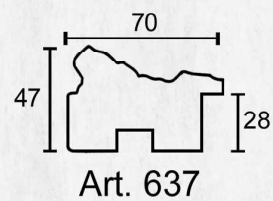
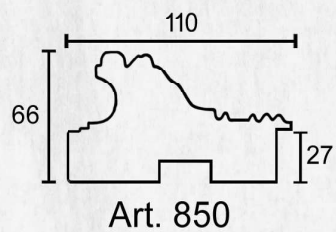
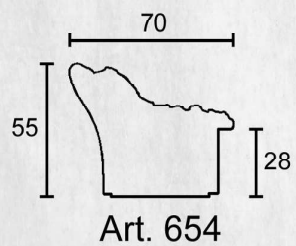
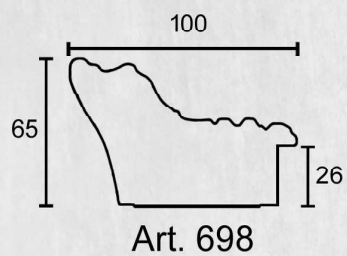

698

654

850

637

434

920
ALTA

920

999

435

726
ALTA

726

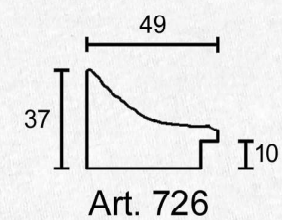
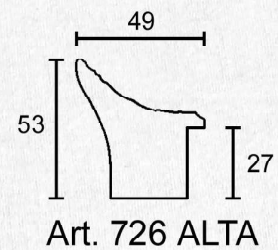
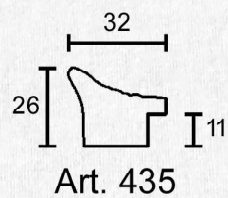
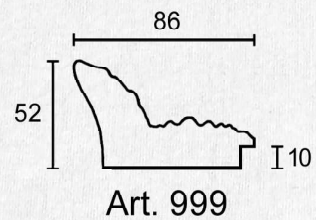
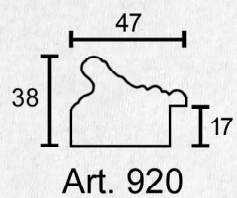

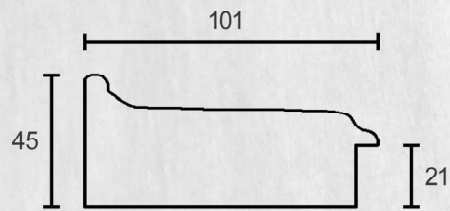

Art. 696/20

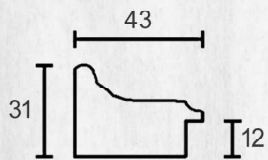

Art. 1696

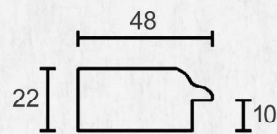

Art. 1697

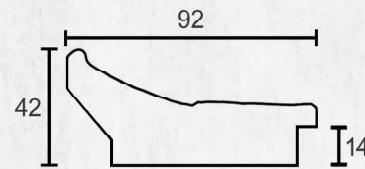

Art. 828

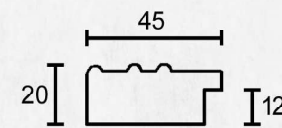

Art. 829



696/20

1696

1697

828

829

827

969

979

469

407

409

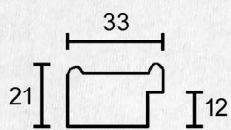

Art. 827

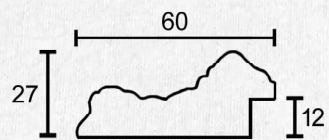

Art. 969

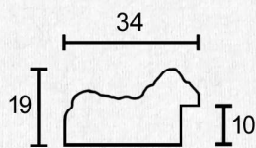

Art. 979

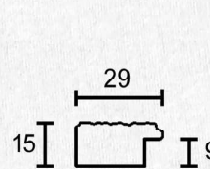

Art. 469

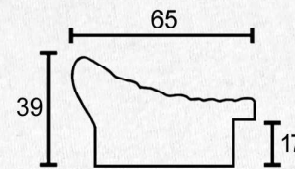

Art. 407

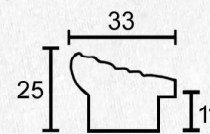

Art. 409

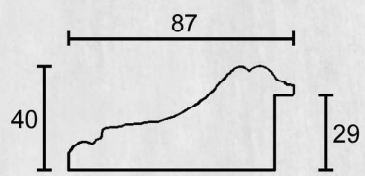

Art. 590

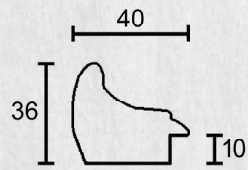

Art. 950

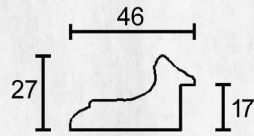

Art. 550

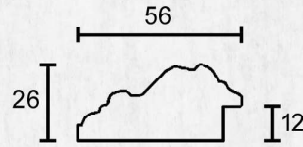

Art. 570

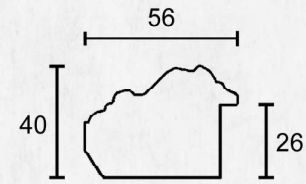

Art. 570 ALTA

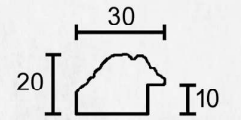

Art. 555



590



950



550



570



570
ALTA



555



580



580
ALTA



560/30



560



575



690

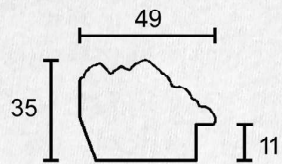

Art. 580

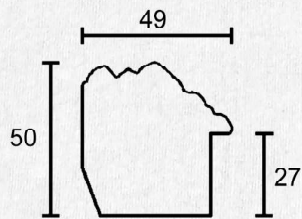

Art. 580 ALTA

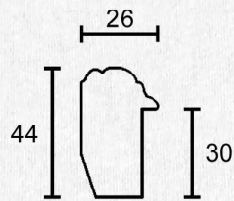

Art. 560/30

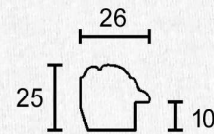

Art. 560

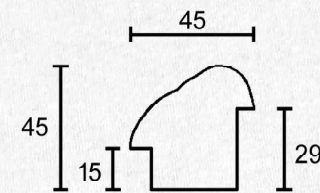

Art. 575

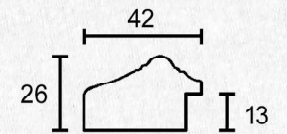

Art. 690

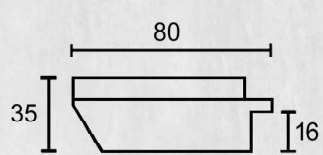

Art. 910

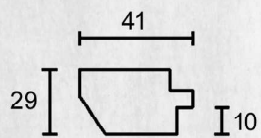

Art. 910/40

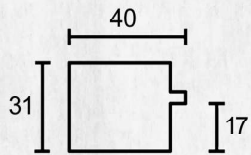

Art. 889/40

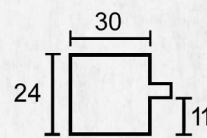

Art. 889

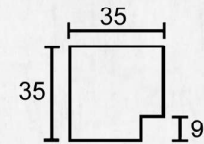

Art. 907

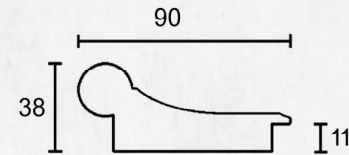

Art. 880 SPAGNA

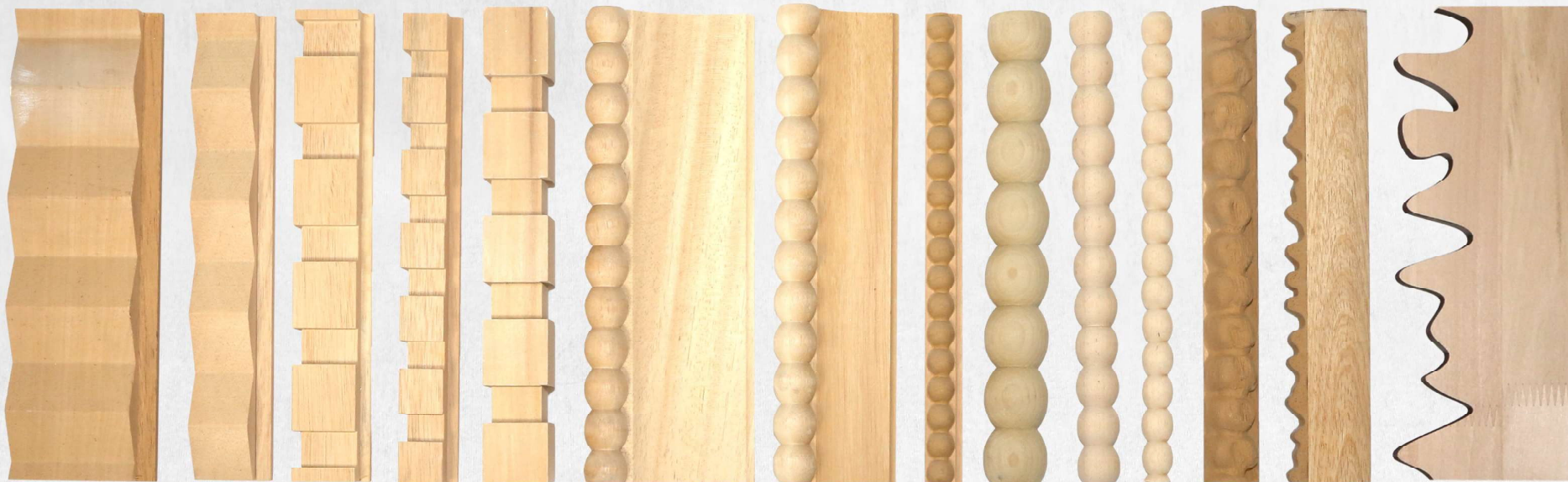

910

910/40

889/40

889

907

880
SPAGNA

880

945

890

888

886

887

993

990

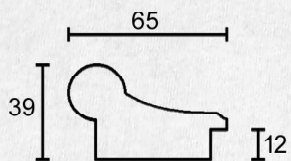

Art. 880

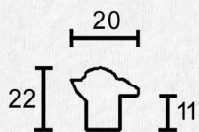

Art. 945

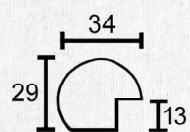

Art. 890



Art. 888

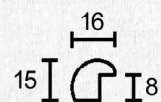

Art. 886

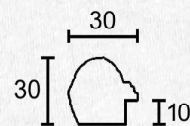

Art. 887

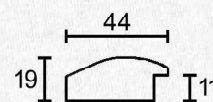

Art. 993

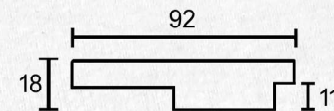

Art. 990

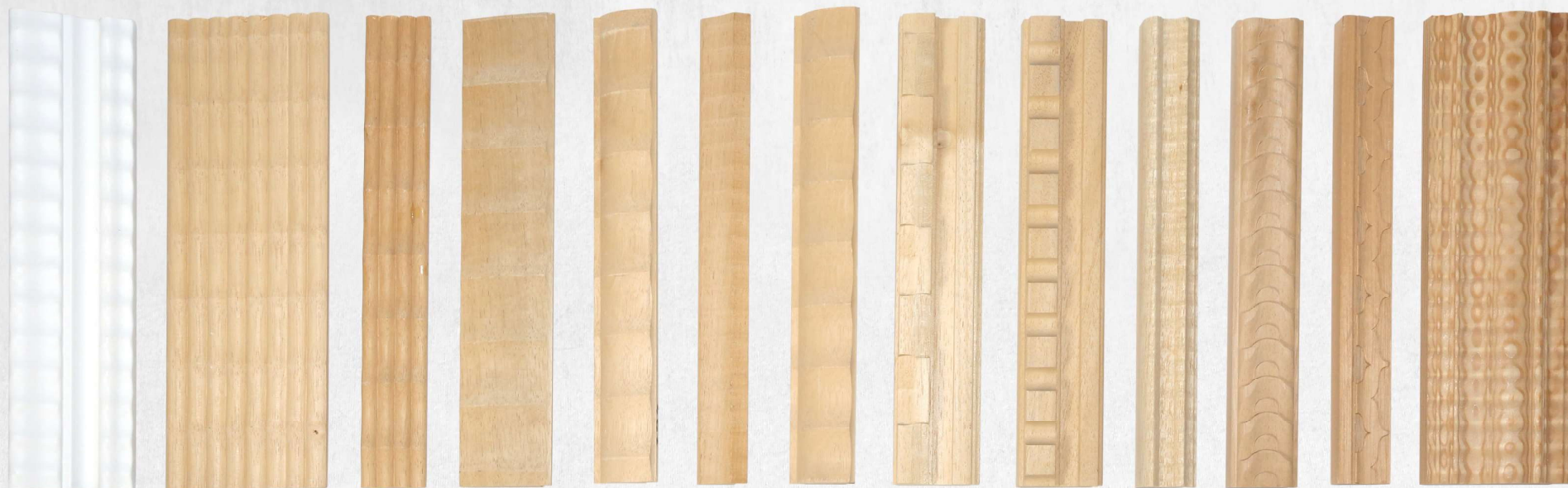
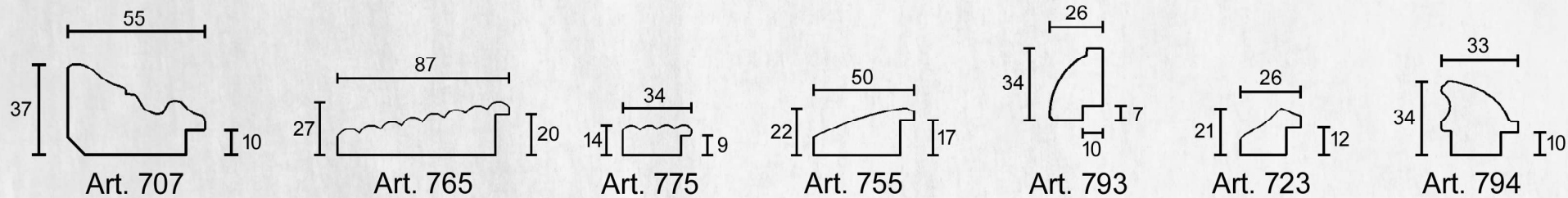

707 765 775 755 793 723 794 638 MOD. 638 DECO 714 1201 761 715

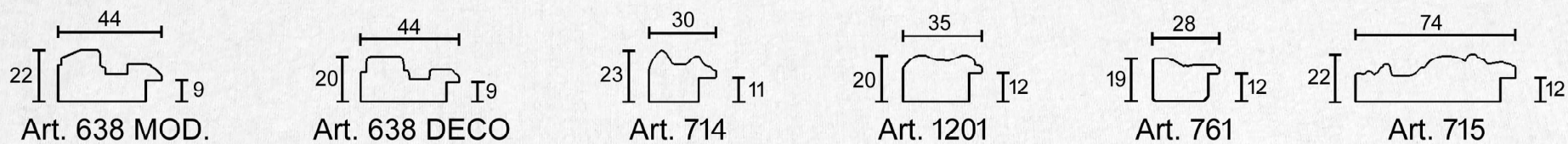

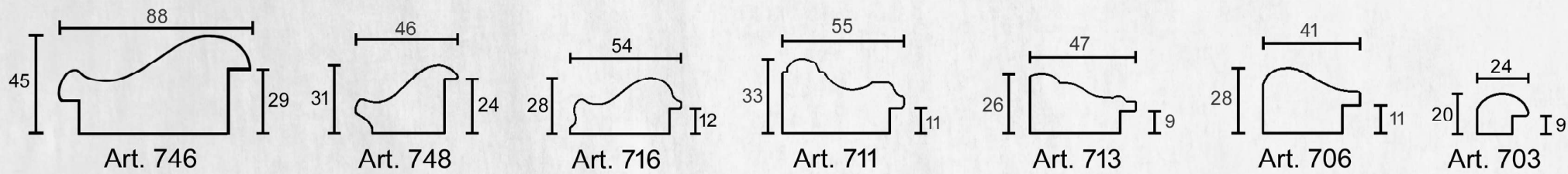

746 748 716 711 713 706 703 700/ 700 701/ 701/ 701 702R 702 PIP 702
 25 30 25

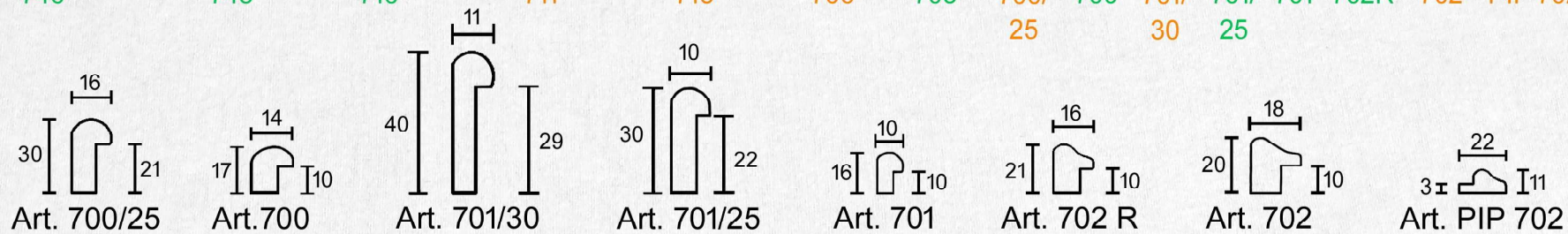

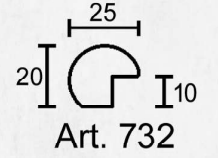
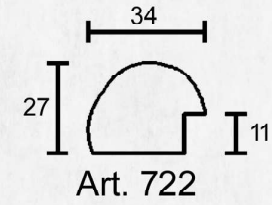
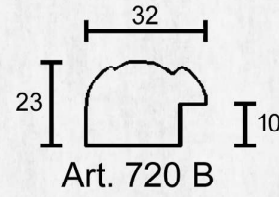
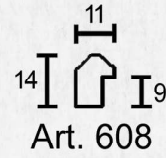
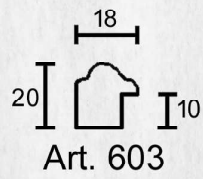
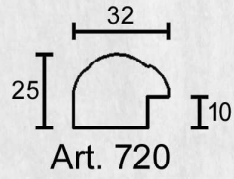
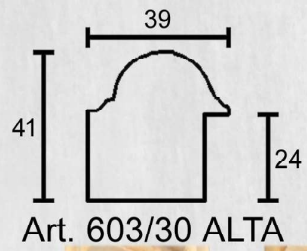

603/30
ALTA

720

603

608

720 B

722

732

738

734

733

603/25

603/20

603/15

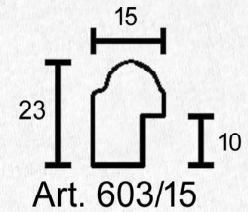
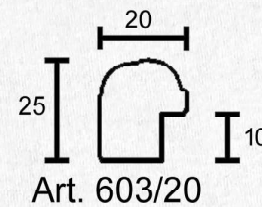
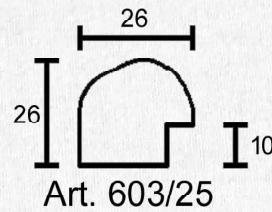
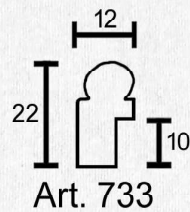
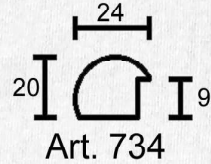
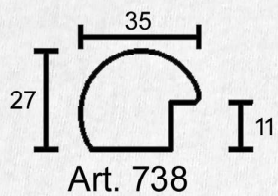

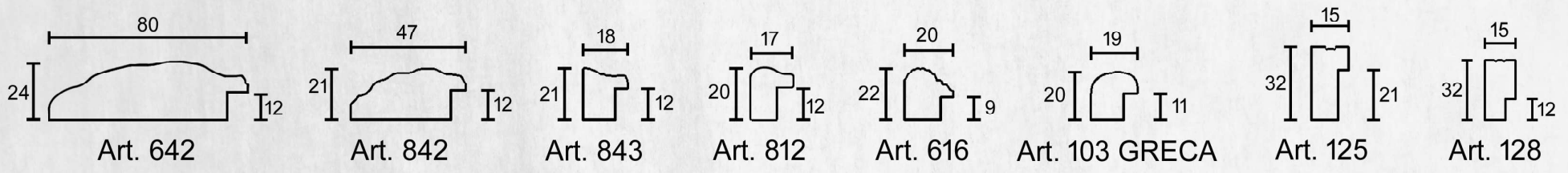

642 842 843 812 616 103 125 128 928 689 631 610 652 626 146 632 633
 GRECA TORT.

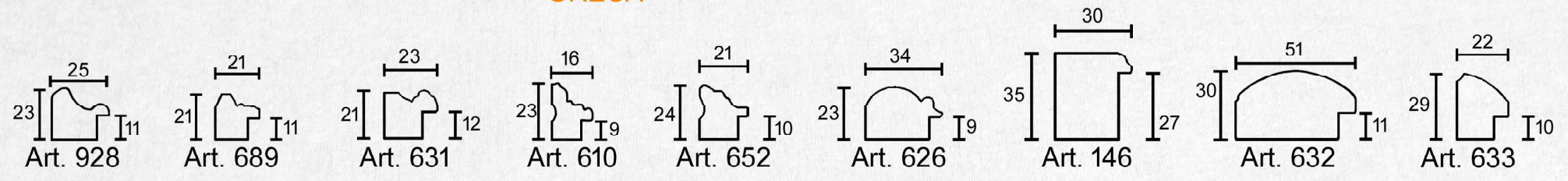

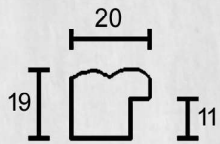

Art. 562

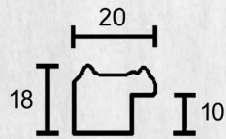

Art. 594

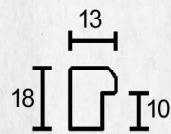

Art. 596

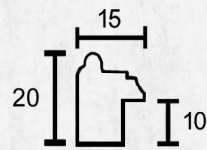

Art. 613

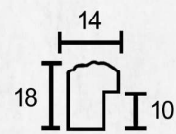

Art. 614

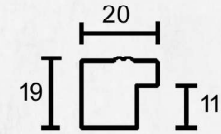

Art. 617



562



594



596



613



614



617



627



649



649



688



735



862



956

SPECIAL

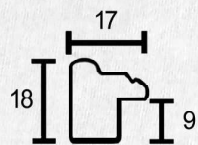

Art. 627

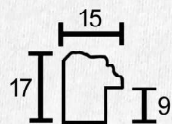

Art. 649

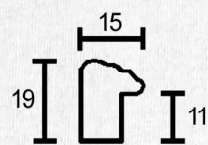

Art. 649

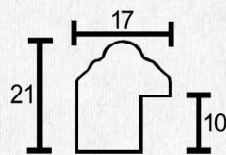

Art. 688

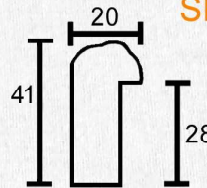

Art. 735

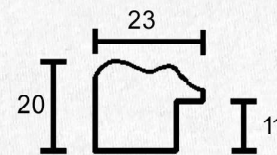

Art. 862

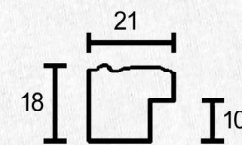

Art. 956

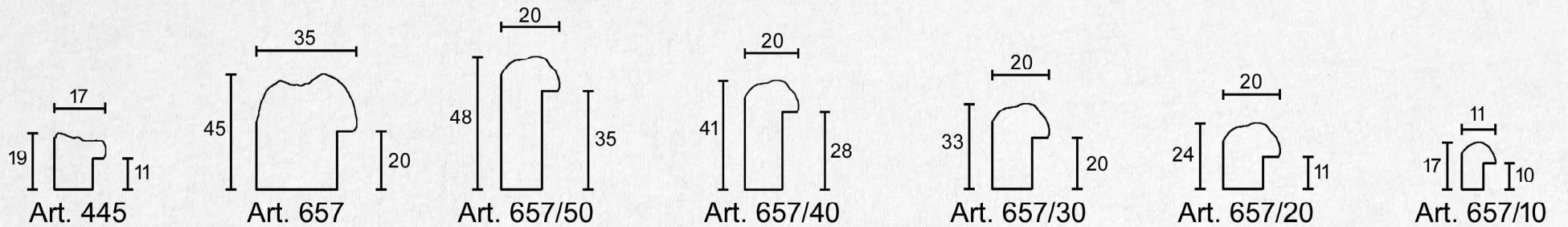
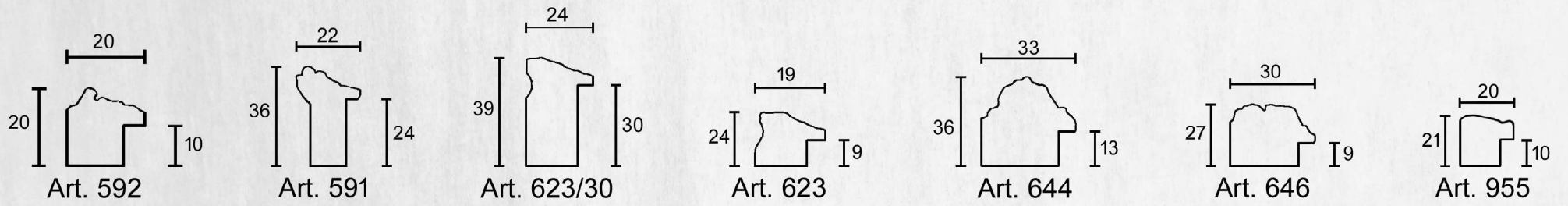

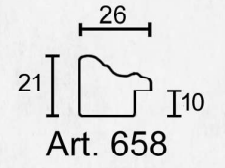
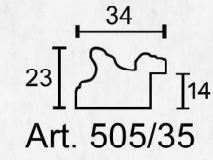
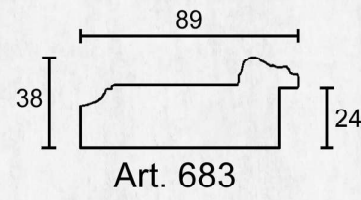
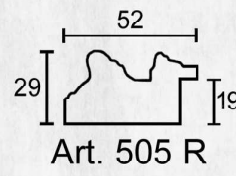
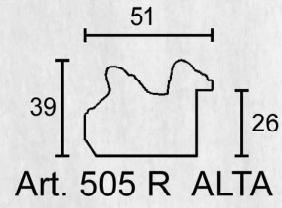
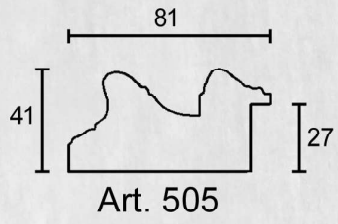

505 505R ALTA 505 R 683 505/35 658 678 681 673 682 505 R GUILL. 505/35 GUILL.

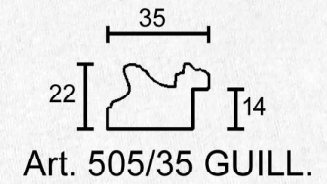
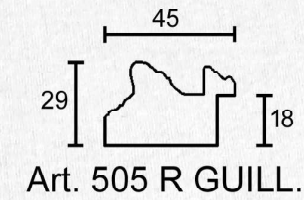
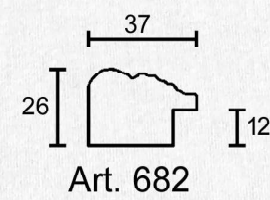
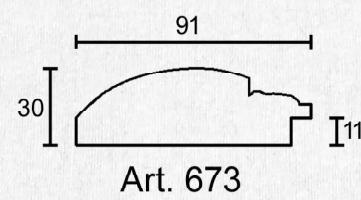
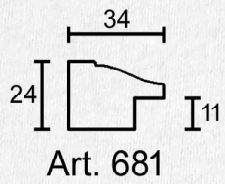
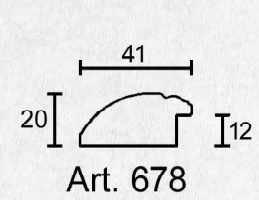

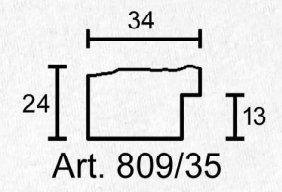
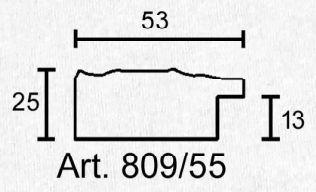
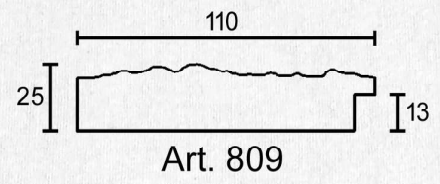
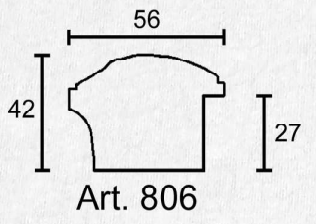
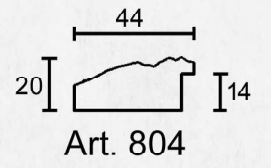
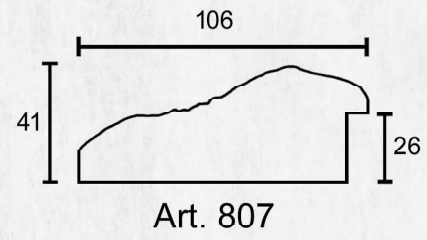
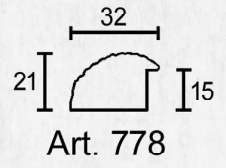
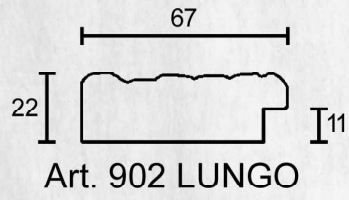
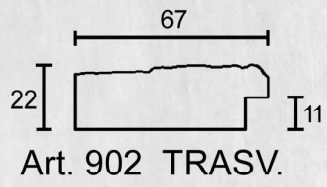

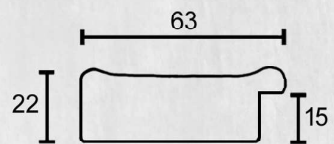

Art. 693

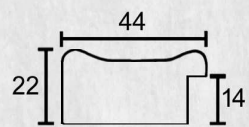

Art. 692

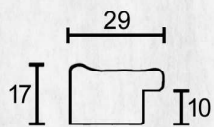

Art. 691

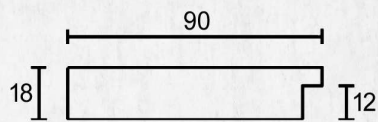

Art. 810/90

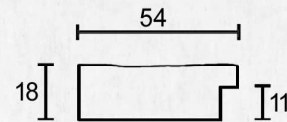

Art. 810

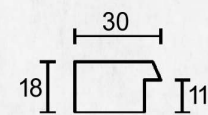

Art. 810/30



693

692

691

810/90

810

810/
30

810/
20

810/
16

900

176

905

904

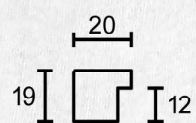

Art. 810/20

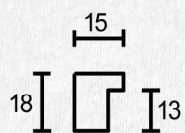

Art. 810/16

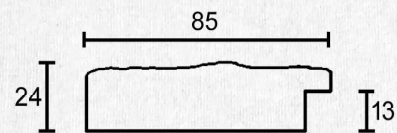

Art. 900

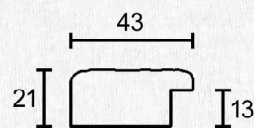

Art. 176

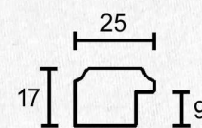

Art. 905

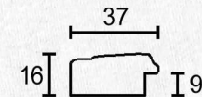

Art. 904

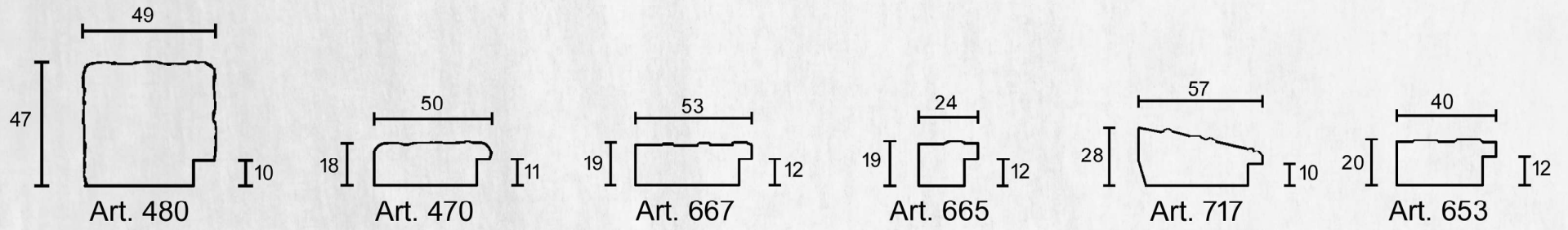

480 470 667 665 717 653 808 925 947 948 995 1221 615

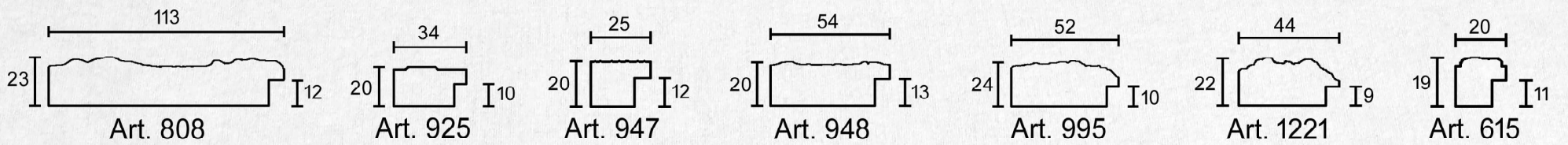

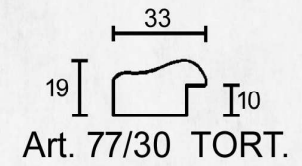
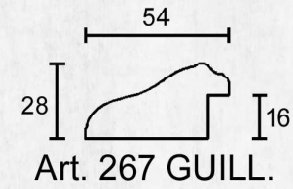
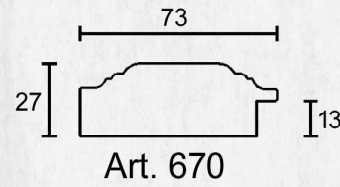
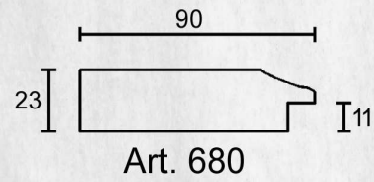
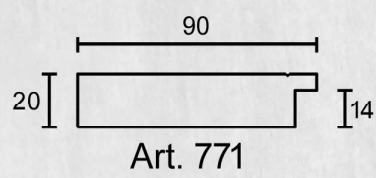

771



680



670



267
GUILL. 77/30
TORT.



1738



PR 45



PR 25



190



160

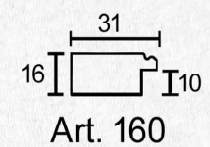
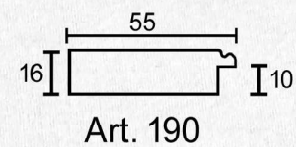
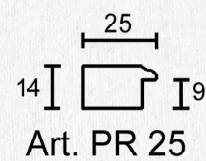
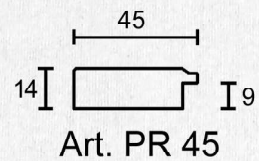
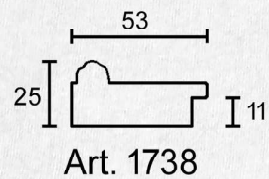

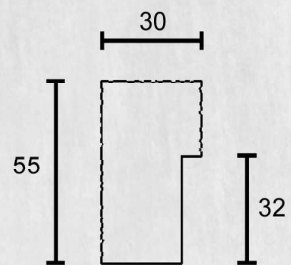

Art. 140/30x55
GRE

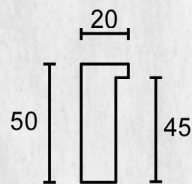

Art. 140/20x50
GRE

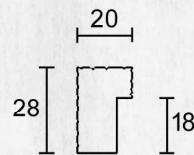

Art. 140/20x28
GRE

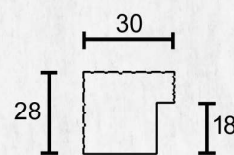

Art. P30x28
GRE

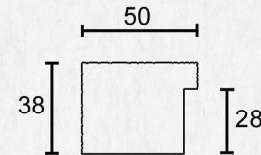

Art. P50x38
GRE

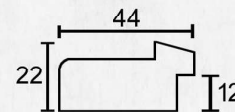

Art. 927 RUS



140/
30x55
GRE

140/
20x50
GRE

140/
20x28
GRE

P30x28
GRE

P50x38
GRE

927
RUS

926
RUS

P20
APR

P20
FLEX

P30
APR

P40
FLEX

83
FLEX

PS 41
APR

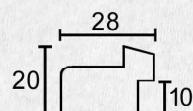

Art. 926
RUS

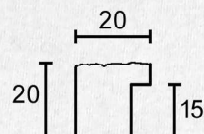

Art. P20
APR

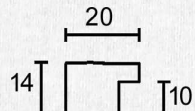

Art. P20
FLEX

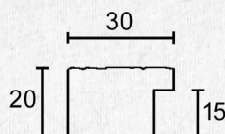

Art. P30
APR

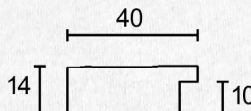

Art. P40
FLEX

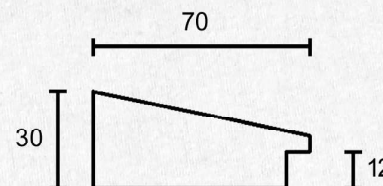

Art. 83
FLEX

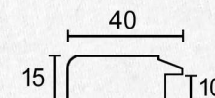

Art. PS 41
APR

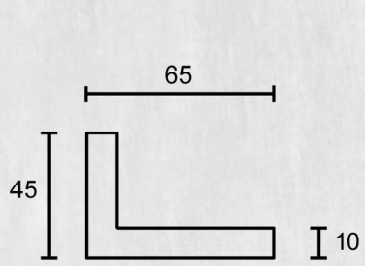

Art. L 45X65

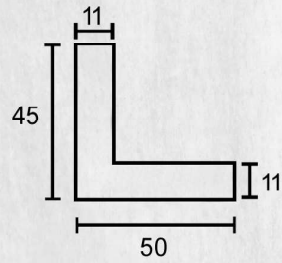

Art. L 45X50

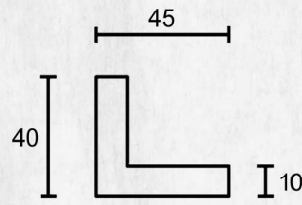

Art. 40X40
ROV

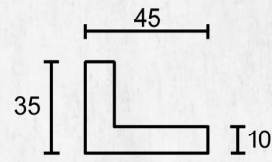

Art. L 35X45

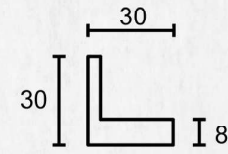

Art. L 30X30
4X8

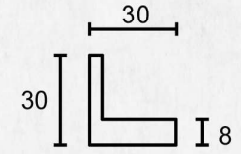

Art. L 30X30
4X8 ROV



L 45X65

L 45X50

L 40X40
ROV

L35X45

L30X30
4X8

L30X30
4X8
ROVERE

725/60
LISCIA

725/60

725

824

251

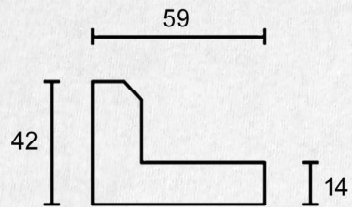

Art. 725/60 LISCIA

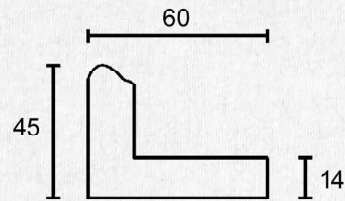

Art. 725/60

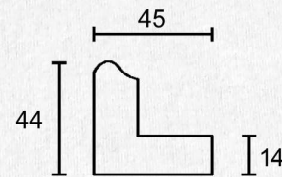

Art. 725

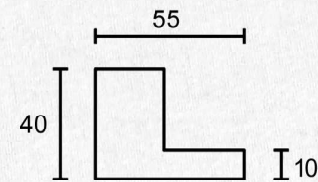

Art. 824

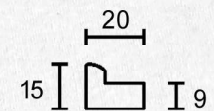

Art. 251

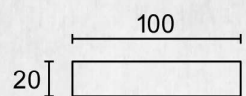

Art.
LISTELLO
100X20

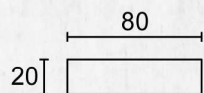

Art.
LISTELLO
80X20

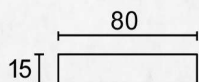

Art.
LISTELLO
80X15

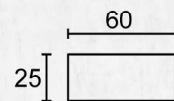

Art.
LISTELLO
60X25

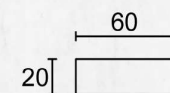

Art.
LISTELLO
60X20

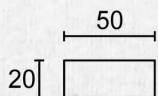

Art.
LISTELLO
50X20

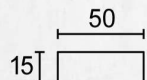

Art.
LISTELLO
50X15

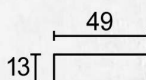

Art.
LISTELLO
50X12

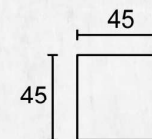

Art.
LISTELLO
45X45



LIST.
100X20

LIST.
80X20

LIST.
80X15

LIST.
60X25

LIST.
60X20

LIST.
50X20

LIST.
50X15

LIST.
50X12

LIST.
45X45

LIST.
30X15

LIST.
20X10

LIST.
18X15

LIST.
15X10

LIST.
10X10

RIAL.
45

RIAL.
25

TELAIO
DS 50

AYOUS

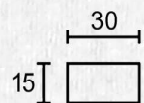

Art.
LISTELLO
30X15

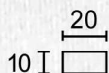

Art.
LISTELLO
20X10

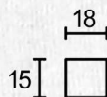

Art. LISTELLO
18X15
AYOUS



Art.
LISTELLO
15X10



Art.
LISTELLO
10X10

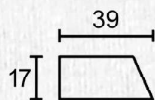

Art. RIALZO 45

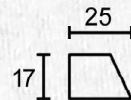

Art. RIALZO 25

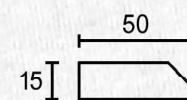

Art. TELAIO DS 50

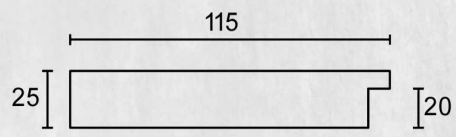

Art. P 110X25

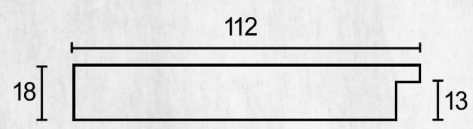

Art. P 110

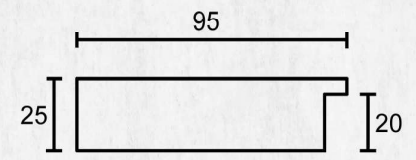

Art. P 95X25

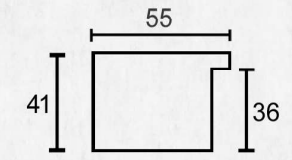

Art. P 56

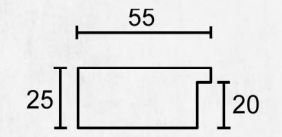

Art. P 55X25



P 110X25

P 110

P 95X25

P 56

P 55X25

P 45X35

P 35X25

P 30X30

P 30X30
D15

P 20X20

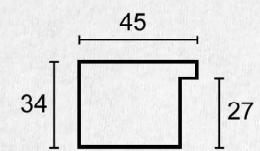

Art. P 45X35

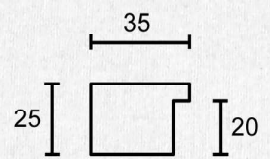

Art. P 35X25

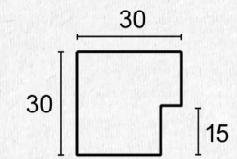

Art. P 30X30

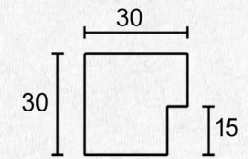

Art. P 30X30
D15

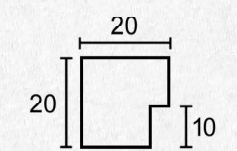

Art. P 20X20

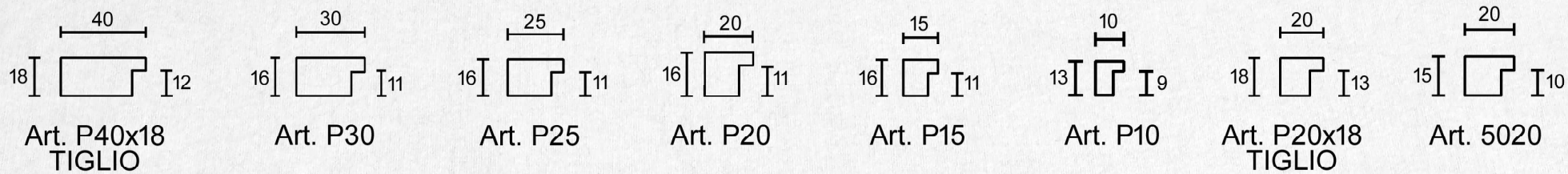
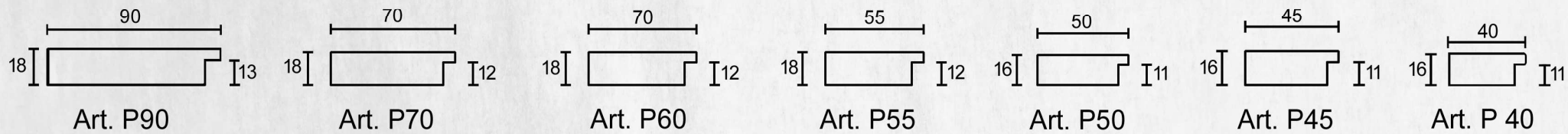

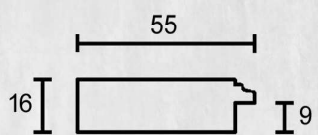

Art. PG 55

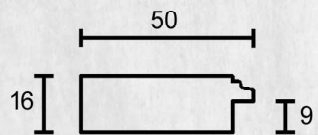

Art. PG 50

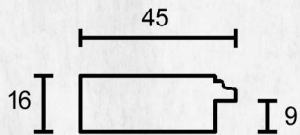

Art. PG 45

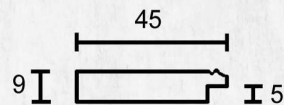

Art. PG 45B

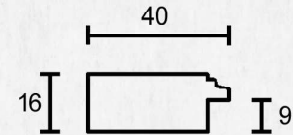

Art. PG 40

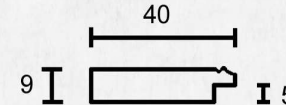

Art. PG 40B



PG 55

PG 50

PG 45

PG 45B

PG 40

PG 40B

PG 35B

PG 30

PG 30B

PG 25B

PG20

PG 15

PG 10

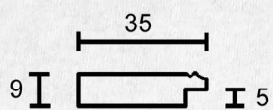

Art. PG 35B

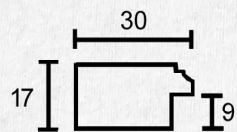

Art. PG 30

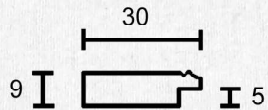

Art. PG 30B

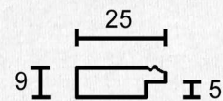

Art. PG 25B

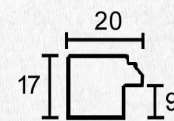

Art. PG 20

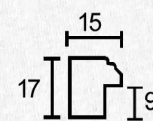

Art. PG 15

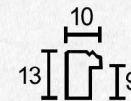

Art. PG 10

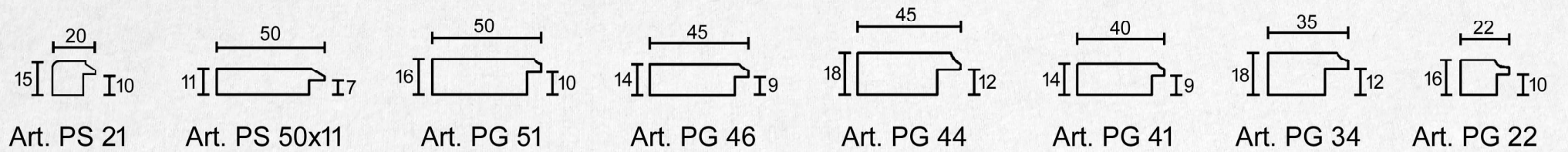
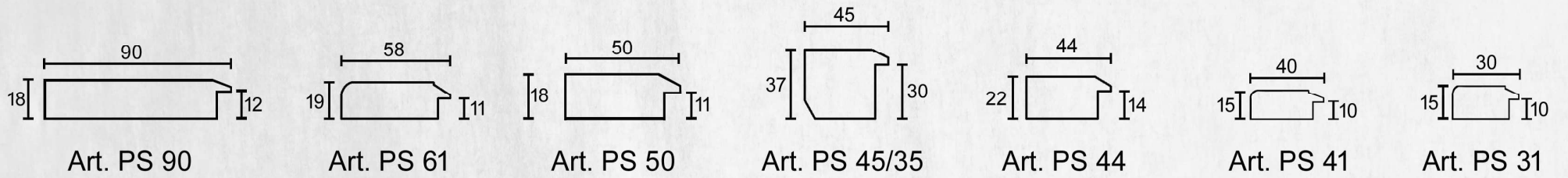

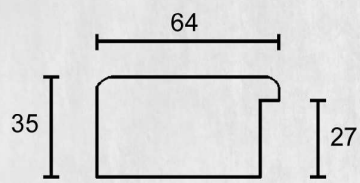

Art. P64x35

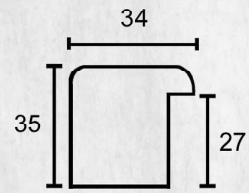

Art. P34x35

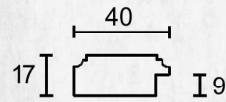

Art. PG2/40

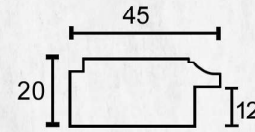

Art. 413

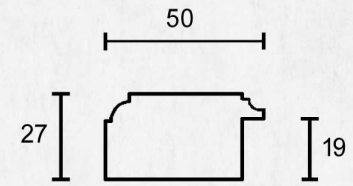

Art. 154/50 ALTA



P64x35

P34x35

PG2/40

413

154/50
ALTA

154/50

154/40

154

113

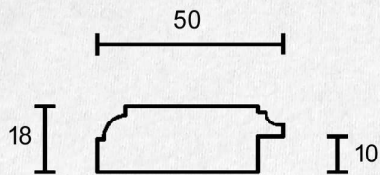

Art. 154/50

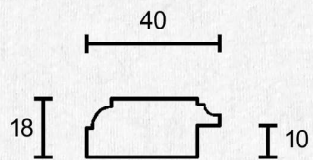

Art. 154/40

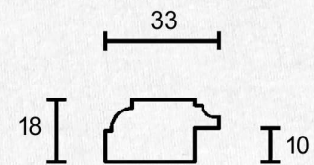

Art. 154

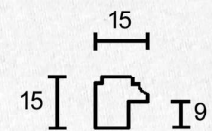

Art. 113

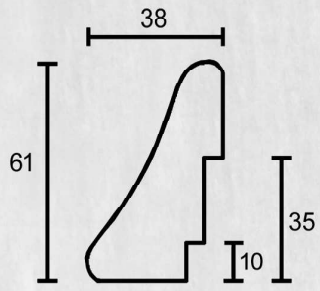

Art. 938

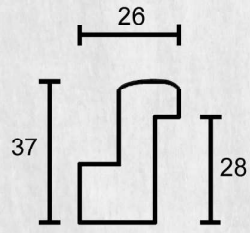

Art. 909 BASE

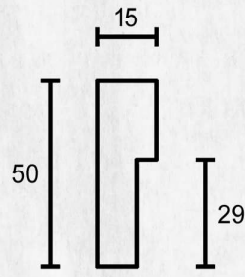

Art. 115

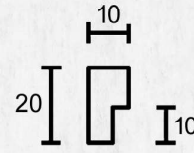

Art. 116

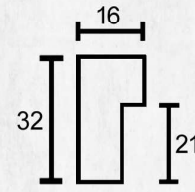

Art. 123

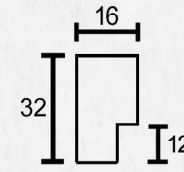

Art. 124

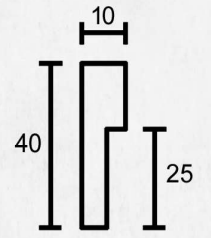

Art. 140/10x40

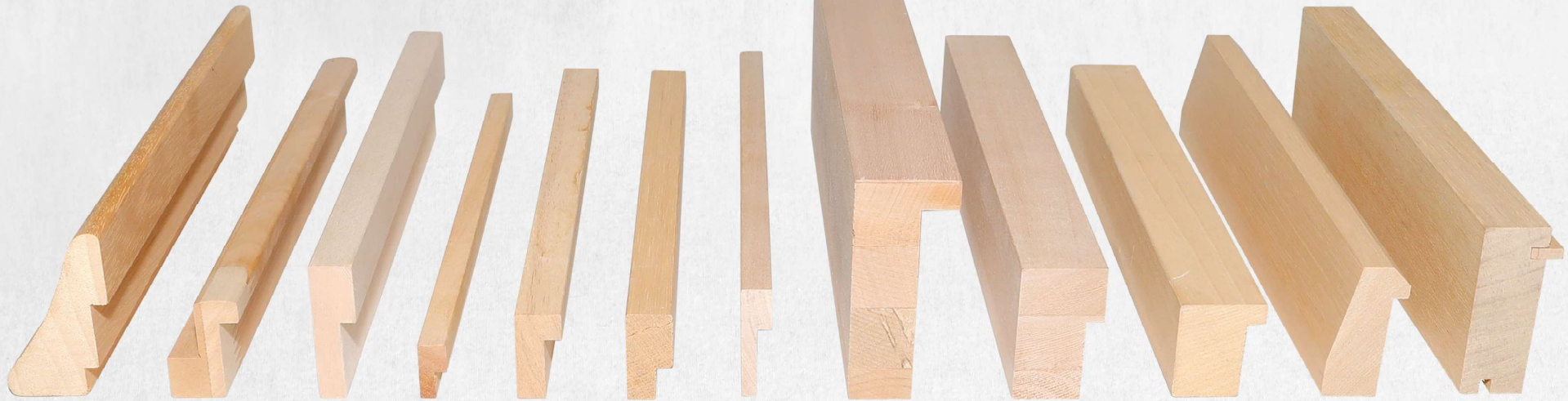

938

909
BASE

115

116

123

124

140/
10x40

140/
35x80

142

146

195

894

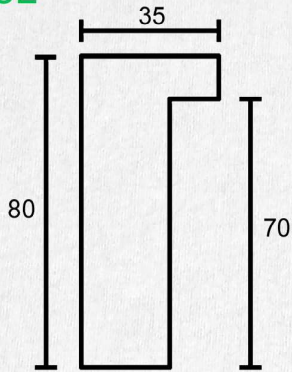

Art. 140/35x80

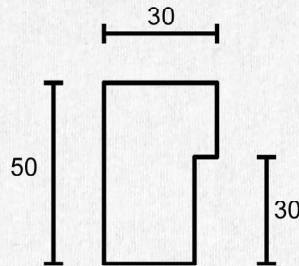

Art. 142

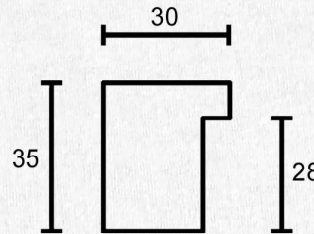

Art. 146

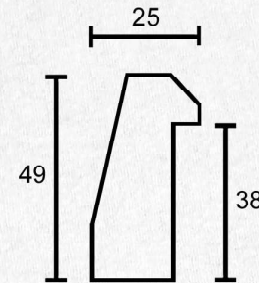

Art. 195

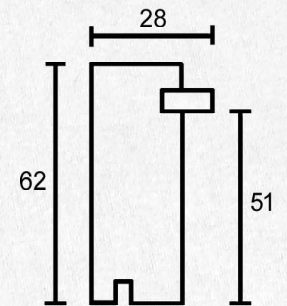

Art. 894

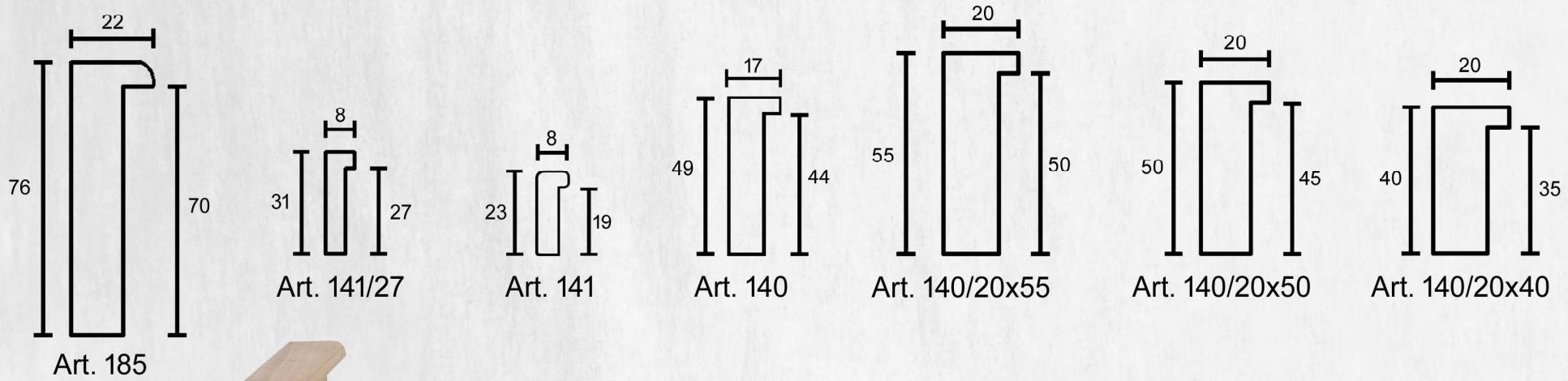

185 141/27 141 140 140/20x55 140/20x50 140/20x40 140/30 140/25x35 140/13x34 140/8x35 140/7x22 140/11x22 121

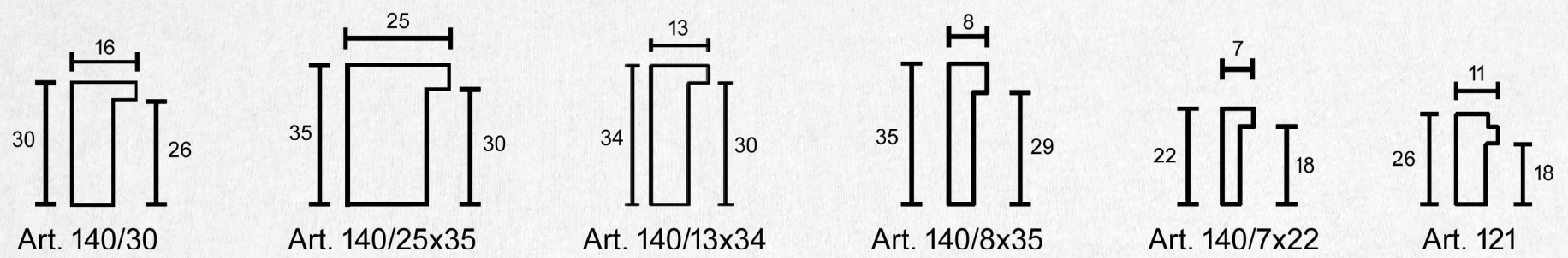

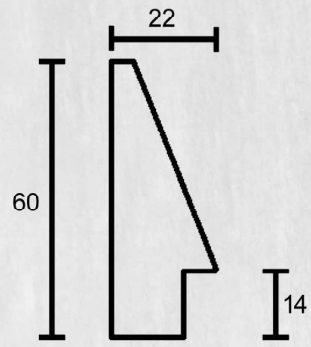

Art. 131/60x25

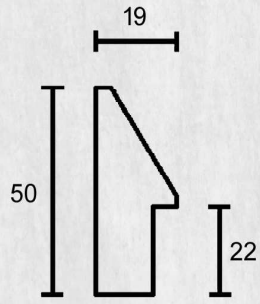

Art. 131/51

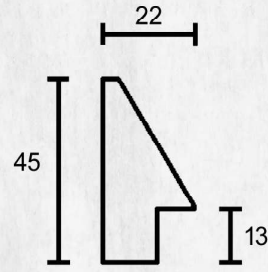

Art. 131/66

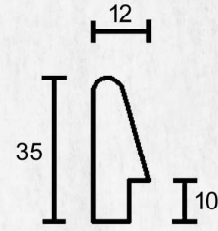

Art. 131/36

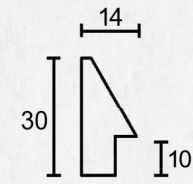

Art. 131/30

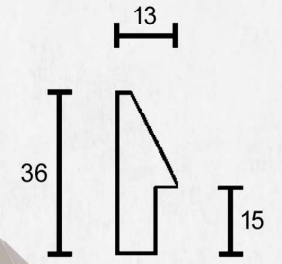

Art. 131/15

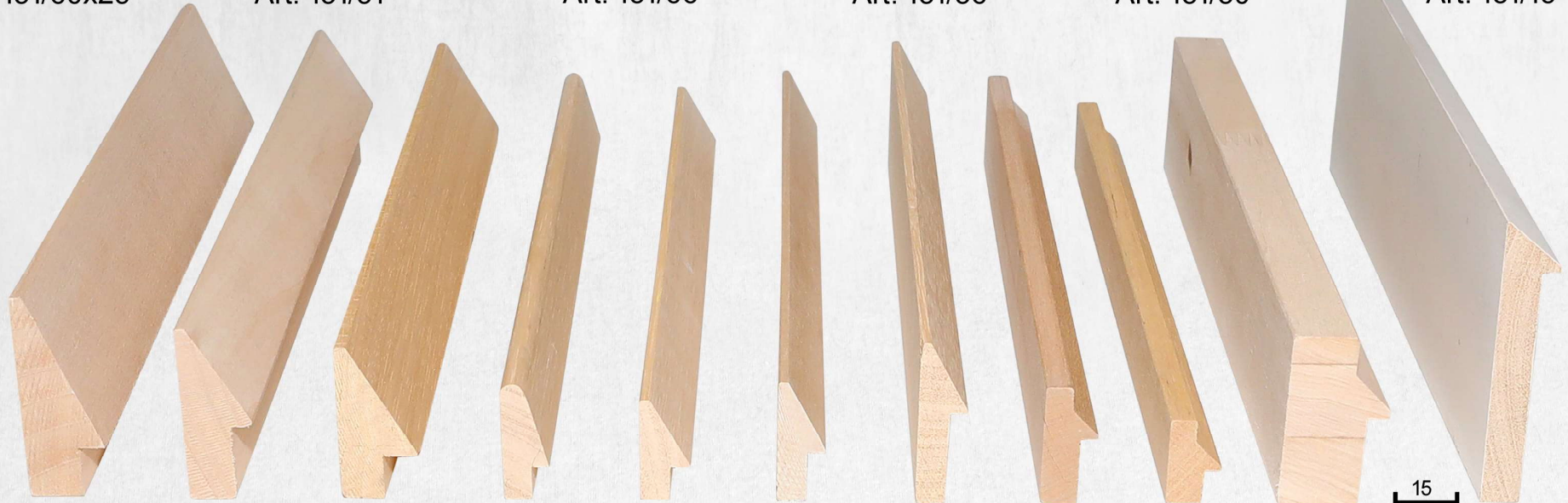

131/
60x25

131/51

131/66

131/36

131/30

131/15

131

167/20

167

164

184

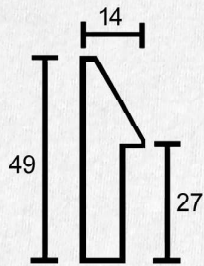

Art. 131

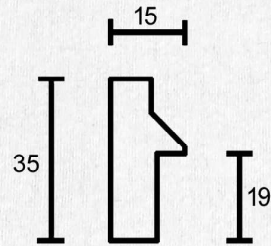

Art. 167/20

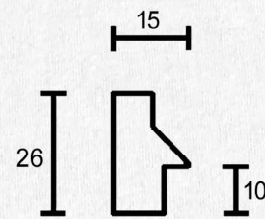

Art. 167

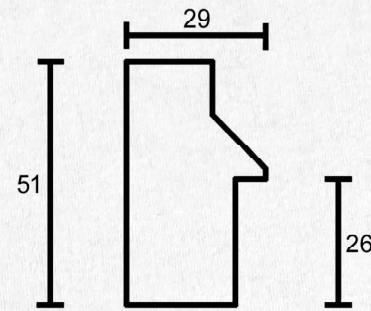

Art. 164

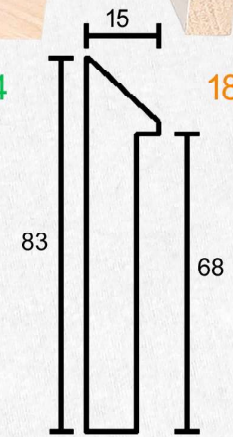

Art. 184

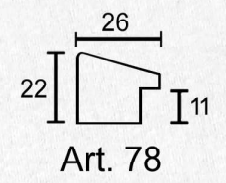
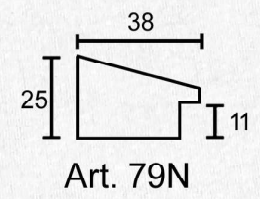
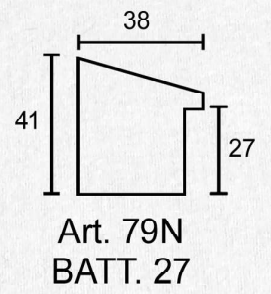
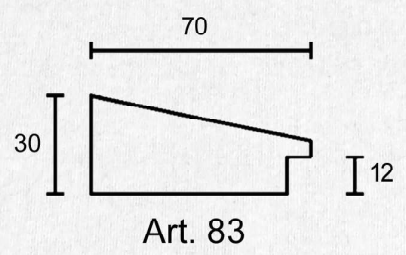
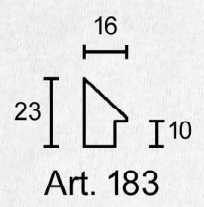
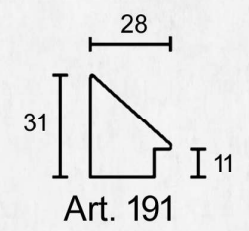
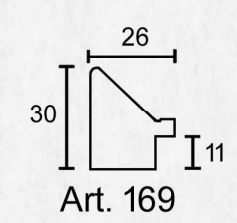
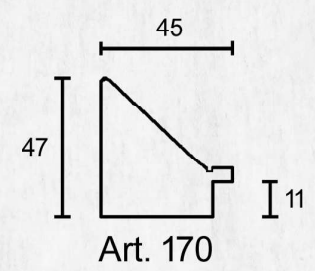
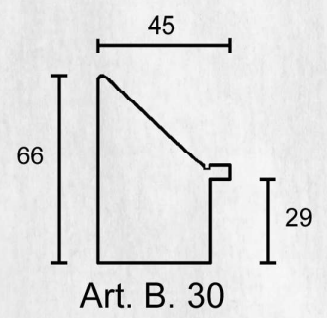
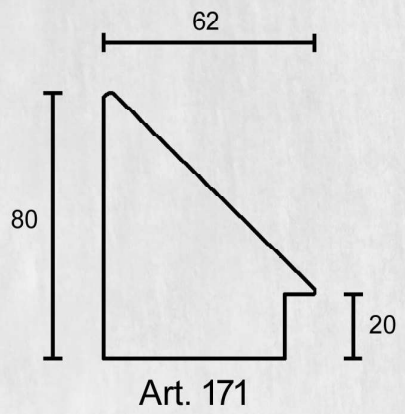

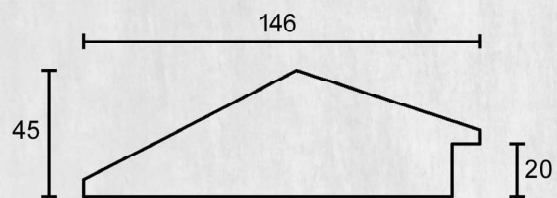

Art. 1164

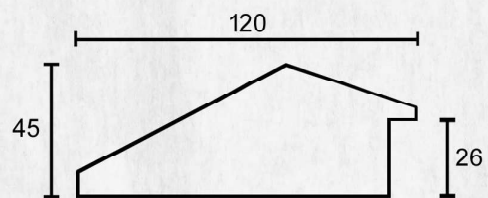

Art. 1163

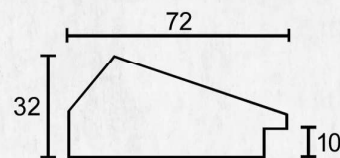

Art. 973

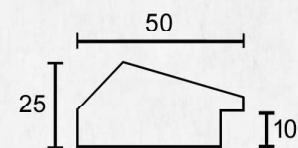

Art. 972



1164

1163

973

972

971

SOLE 5

168

174

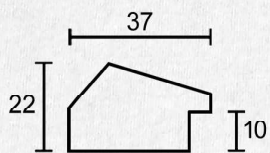

Art. 971

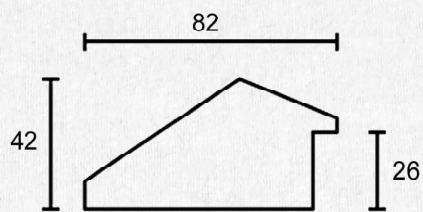

Art. SOLE 5

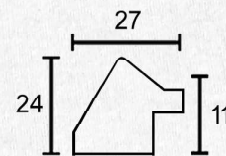

Art. 168

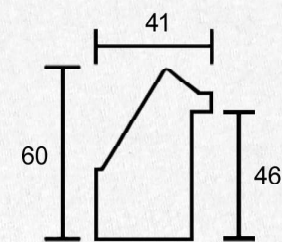

Art. 174

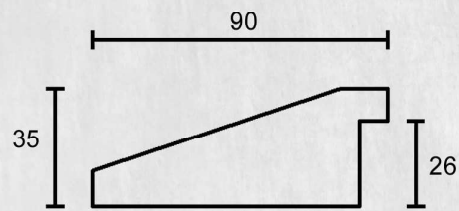

Art. 276/80

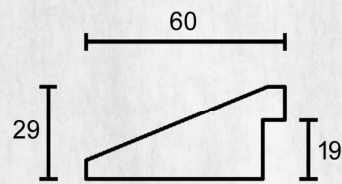

Art. 276/60

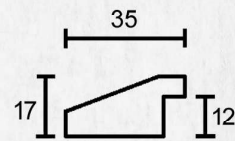

Art. 276/35

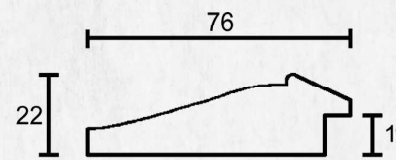

Art. 277

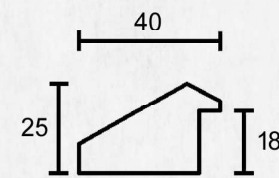

Art. 1166



276/80

276/60

276/35

277

1166

1167

192

108

131/60x27

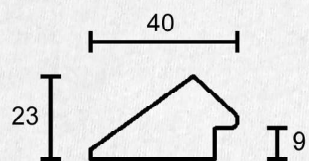

Art. 1167

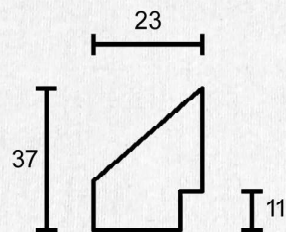

Art. 192

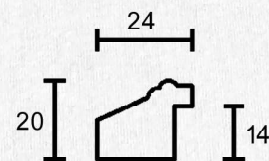

Art. 108

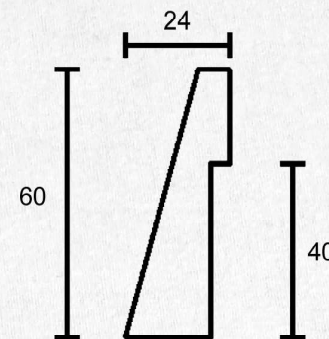

Art. 131/60x27

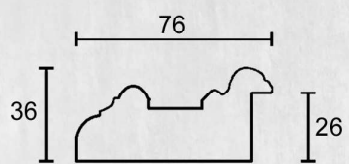

Art. 149

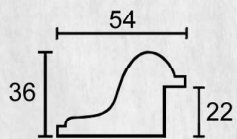

Art. 224/55

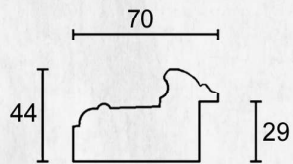

Art. 225

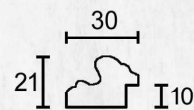

Art. 328

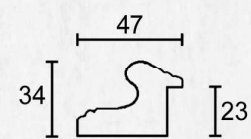

Art. 330

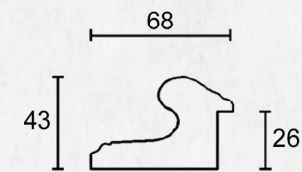

Art. 331



149

224/55

225

328

330

331

401

402

2052

2053

3002

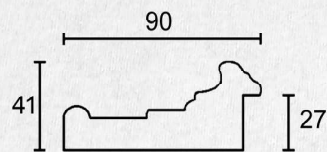

Art. 401

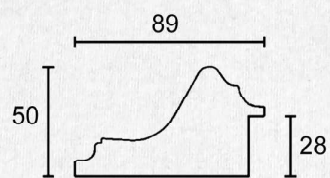

Art. 402

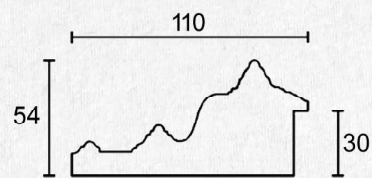

Art. 2052

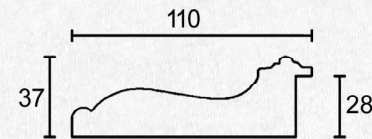

Art. 2053

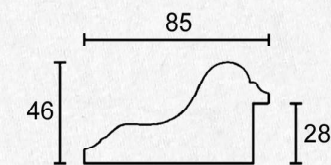

Art. 3002

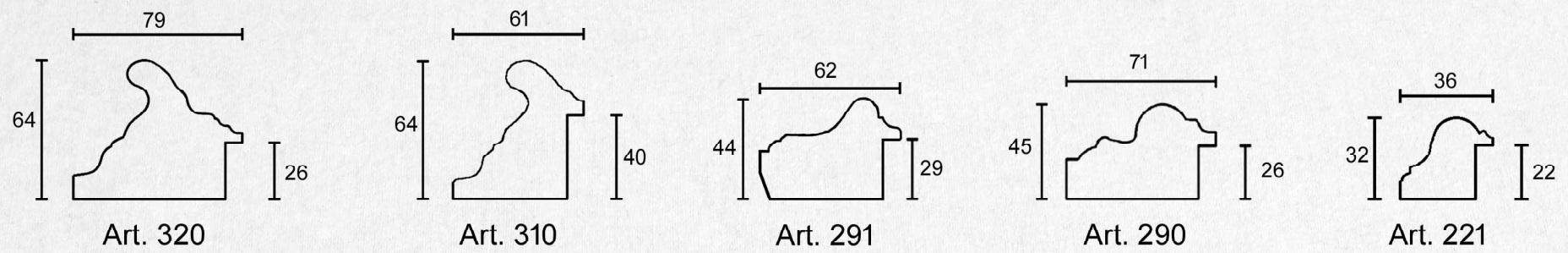
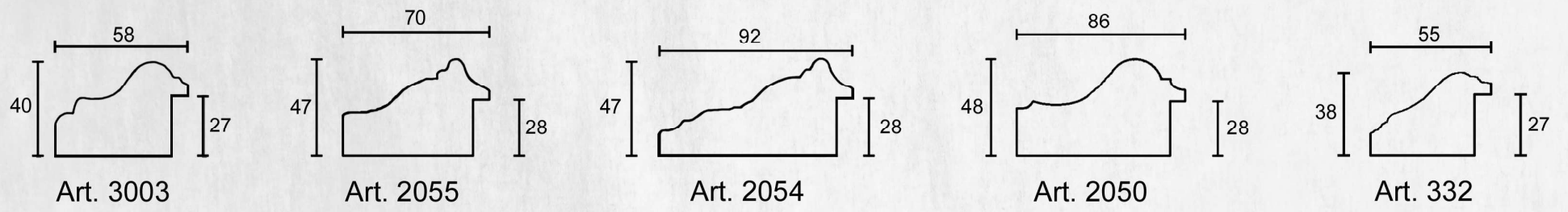

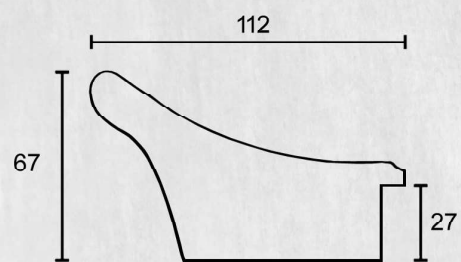

Art. 403

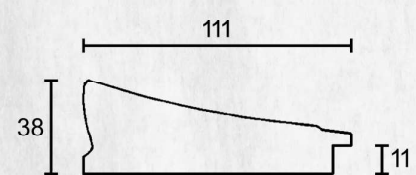

Art. 410

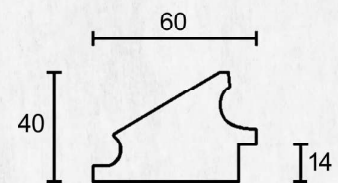

Art. 922

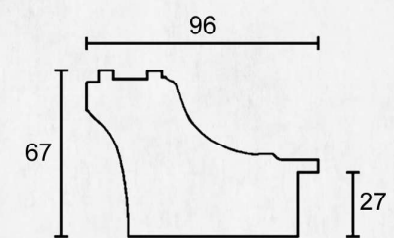

Art. 1601



403

410

922

1601

483
ALTA

483

484

355

100/60

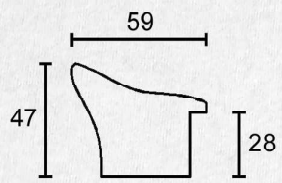

Art. 483 ALTA

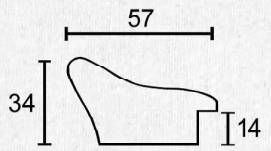

Art. 483

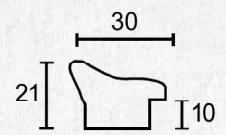

Art. 484

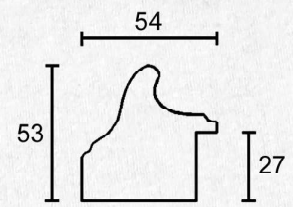

Art. 355

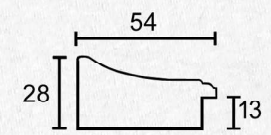

Art. 100/60

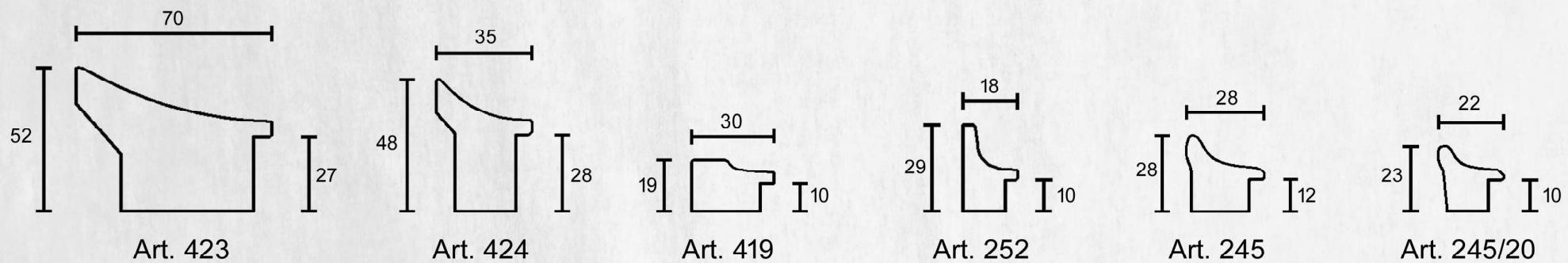

423 424 419 252 245 245/20 120 111/30 111 100/40 524 912

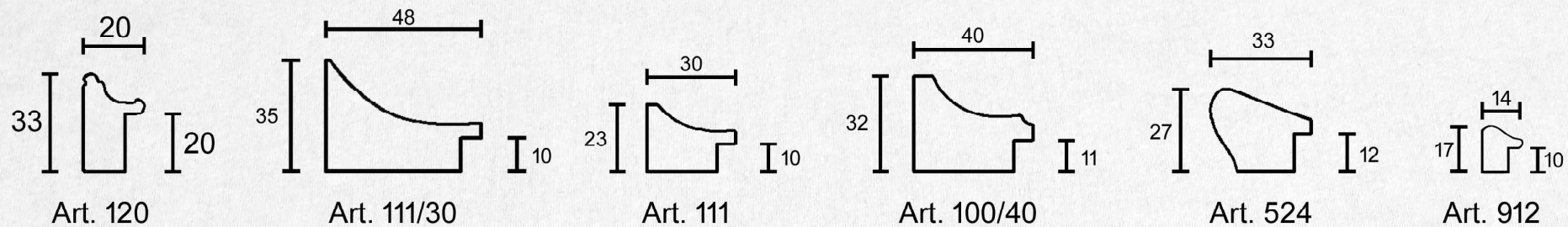

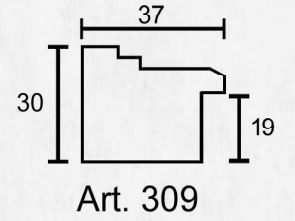
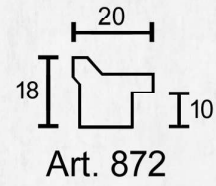
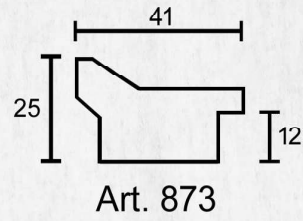
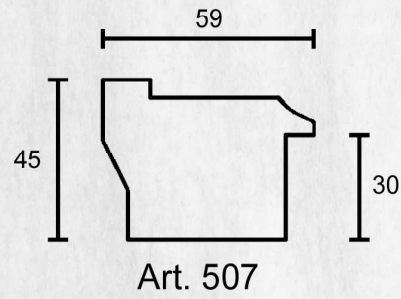
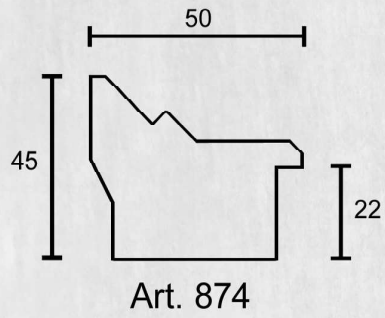

874

507

873

872

309

172

107

75/35

74 FLEX

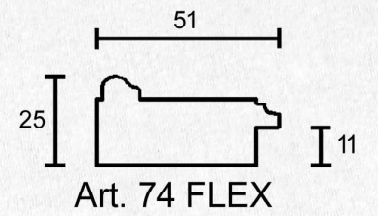
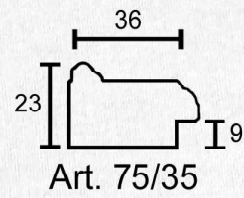
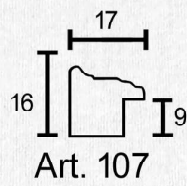
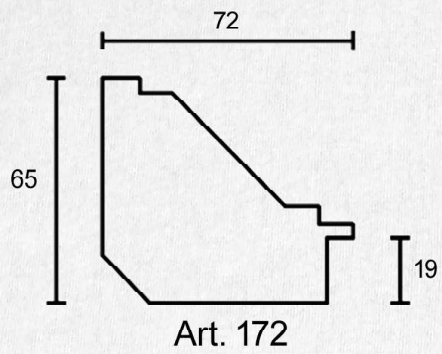

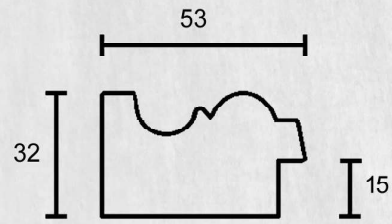

Art. 860

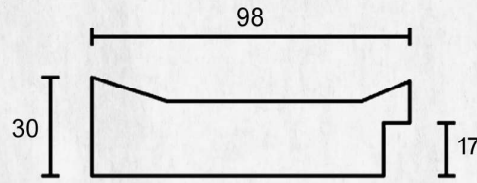

Art. 750

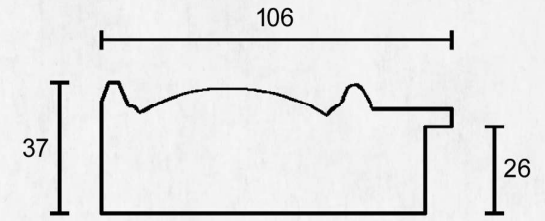

Art. 695 LISCIA



860

750

695 LISCIA

450

390

379

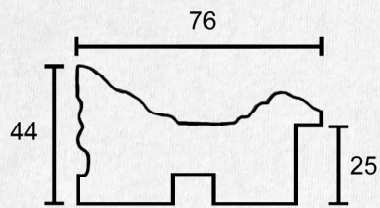

Art. 450

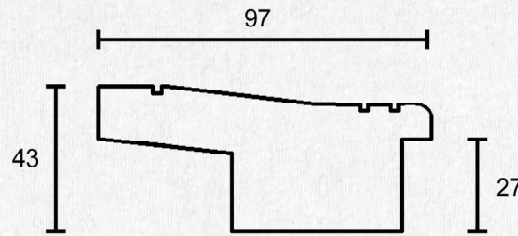

Art. 390

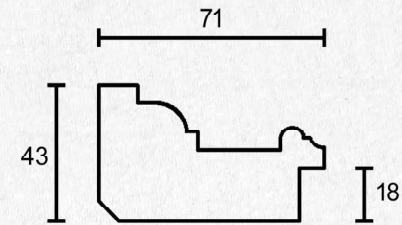

Art. 379

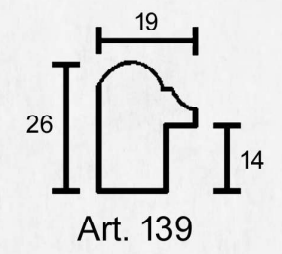
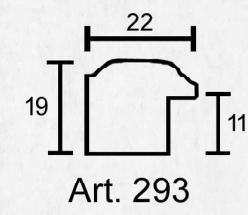
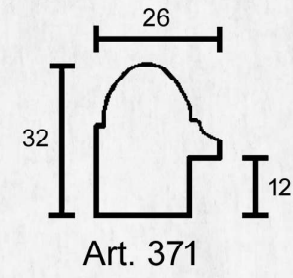
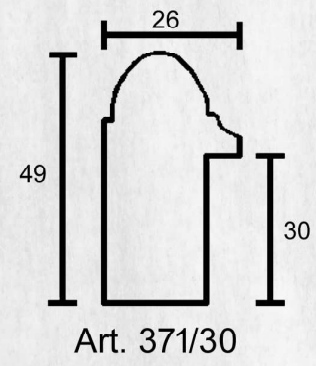
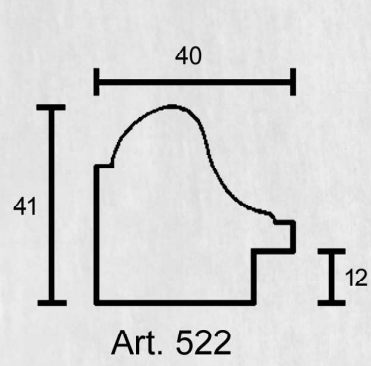

522 371/30 371 293 139 P 36 P 26 P 16 P16 GOYA 202 202 N

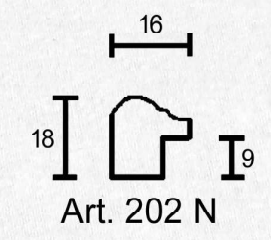
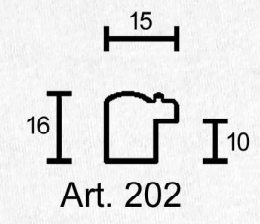
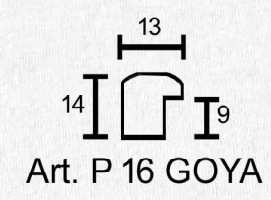
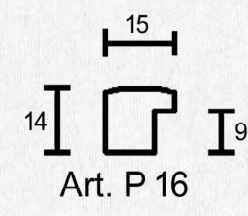
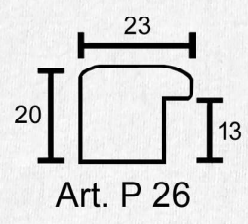
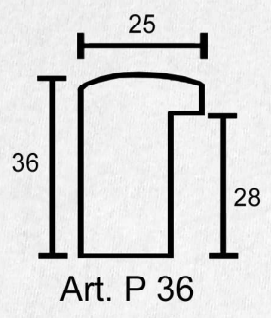

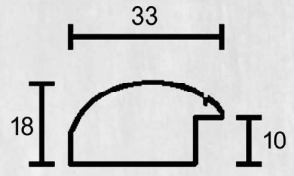

Art. 275

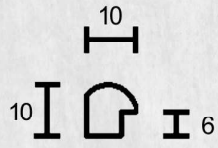

Art. 233

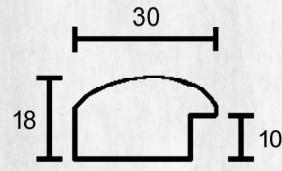

Art. 114

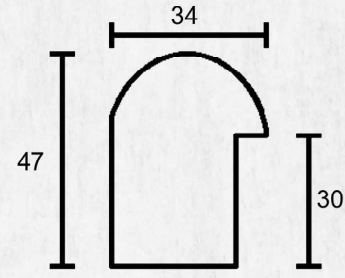

Art. 104 T ALTA

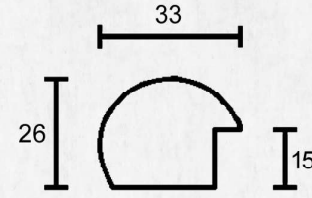

Art. 104

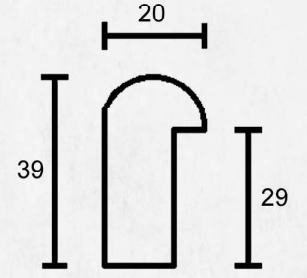

Art. 103/30



275

233

114

104 T ALTA

104

103/30

103 A

103

102/20

102 T

102

101/30

101 GOYA

101

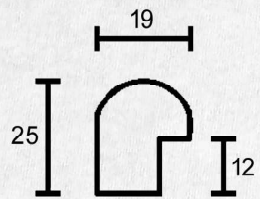

Art. 103 A

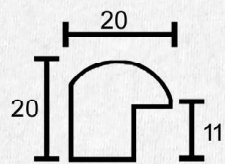

Art. 103

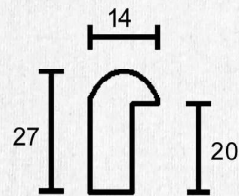

Art. 102/20

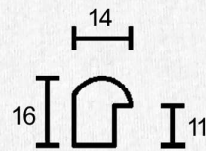

Art. 102 T

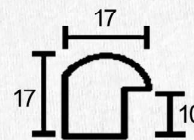

Art. 102

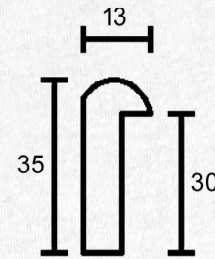

Art. 101/30

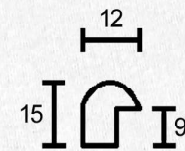

Art. 101 GOYA

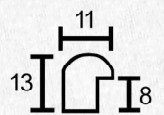

Art. 101

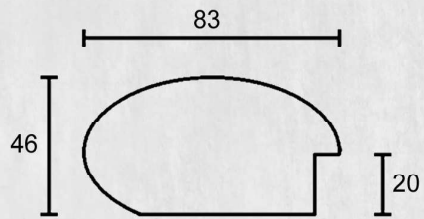

Art. 1014

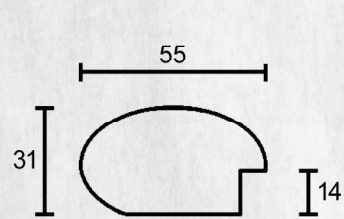

Art. 1013

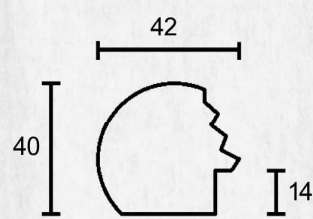

Art. 944

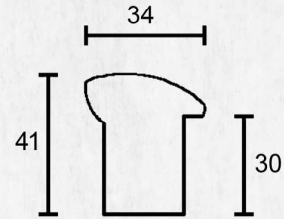

Art. 514/30

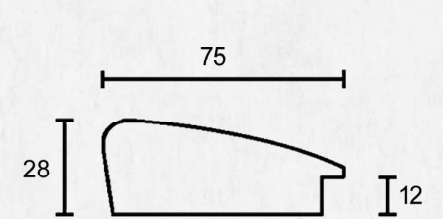

Art. 490



1014

1013

944

514/30

490

491

273

105

105G

531

514

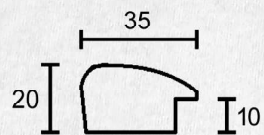

Art. 491

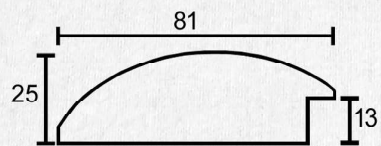

Art. 273

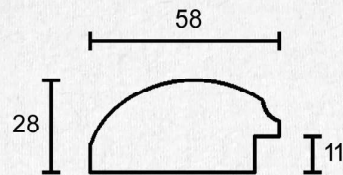

Art. 105

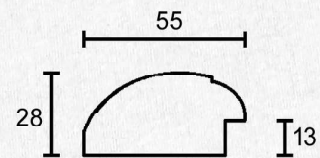

Art. 105G

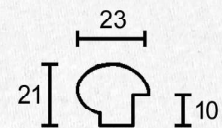

Art. 531

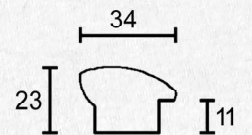

Art. 514

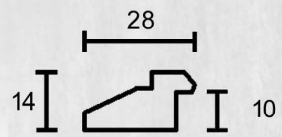

Art. 996

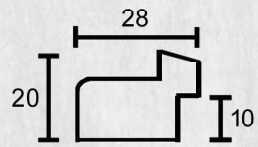

Art. 926

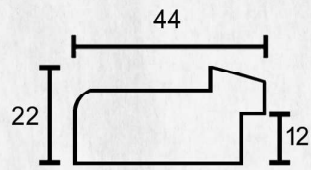

Art. 927

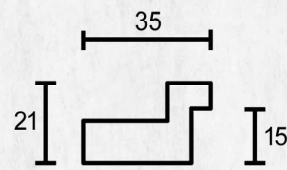

Art. 515

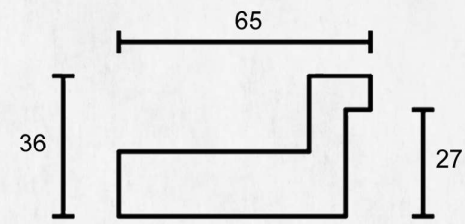

Art. 415



996

926

927

515

415

415/48

41515

244

201 B

201

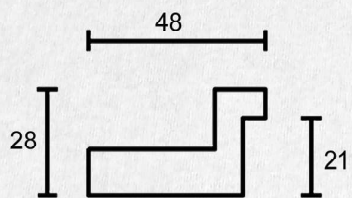

Art. 415/48

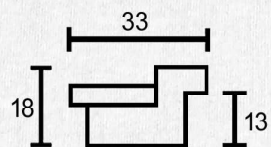

Art. 41515

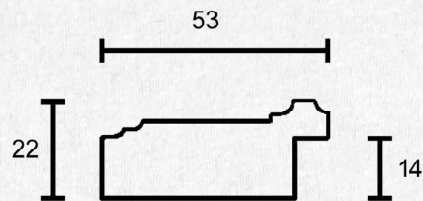

Art. 244

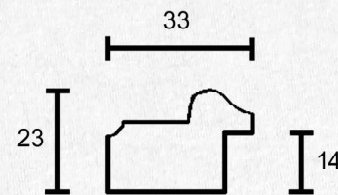

Art. 201 B

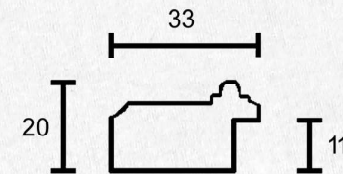

Art. 201

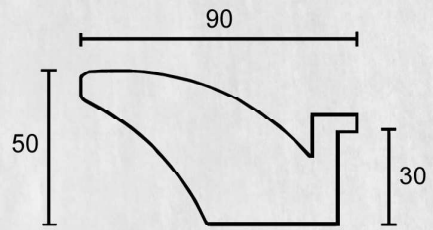

Art. 1103

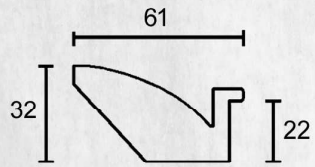

Art. 1102

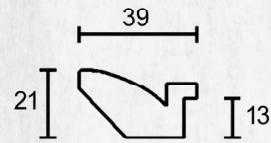

Art. 1101

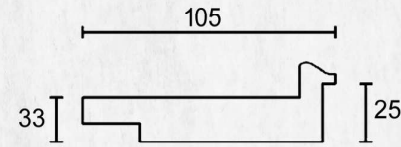

Art. 998

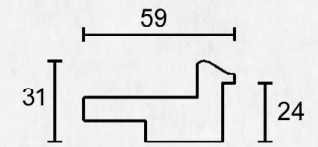

Art. 997

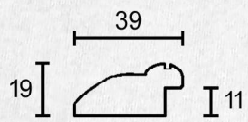

Art. 923

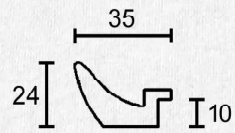

Art. 841

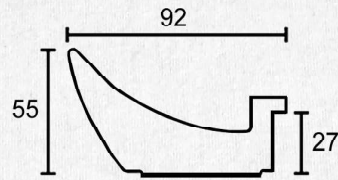

Art. 832

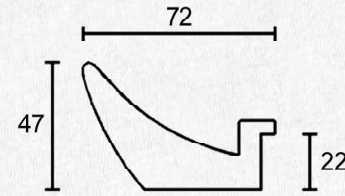

Art. 831

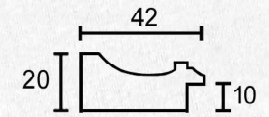

Art. PASS 200

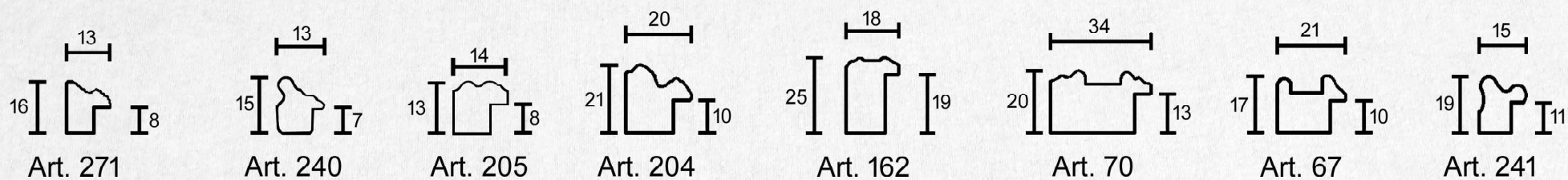
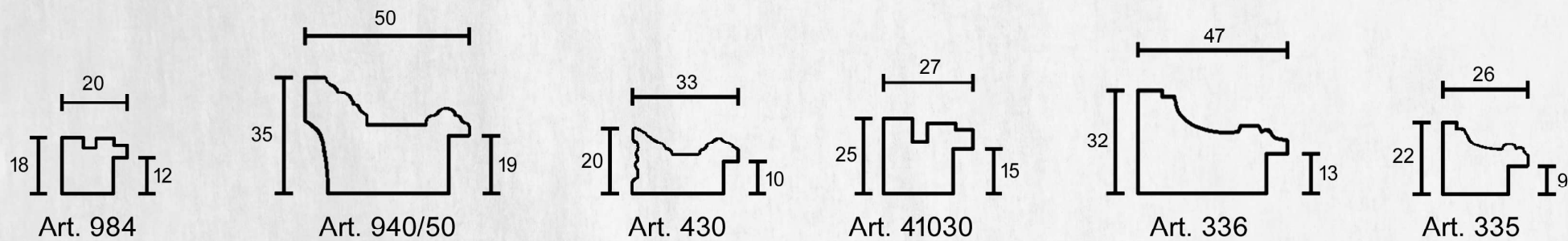

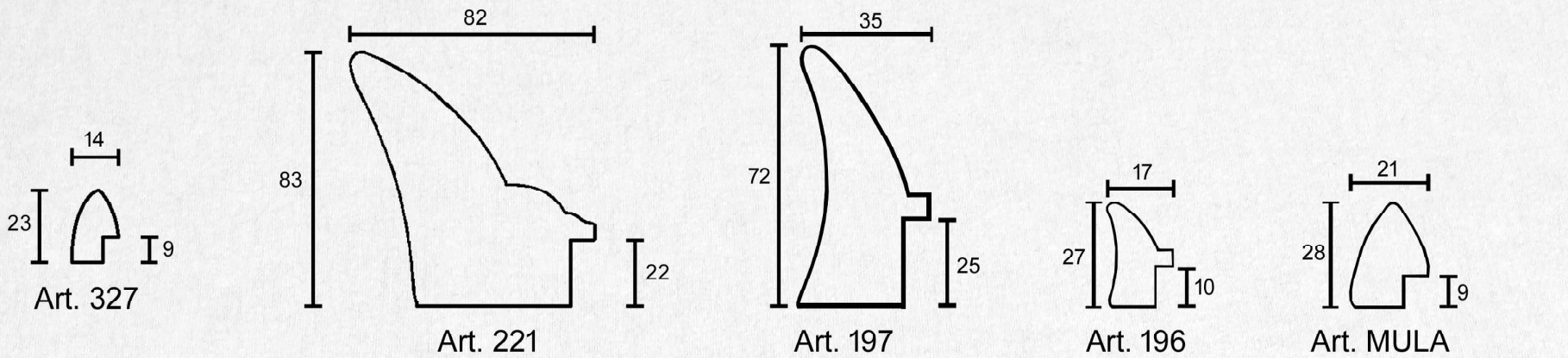
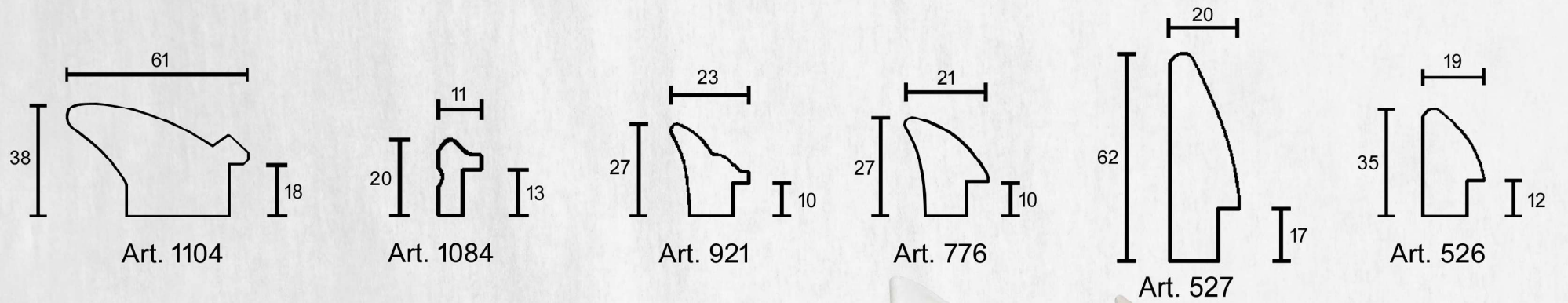

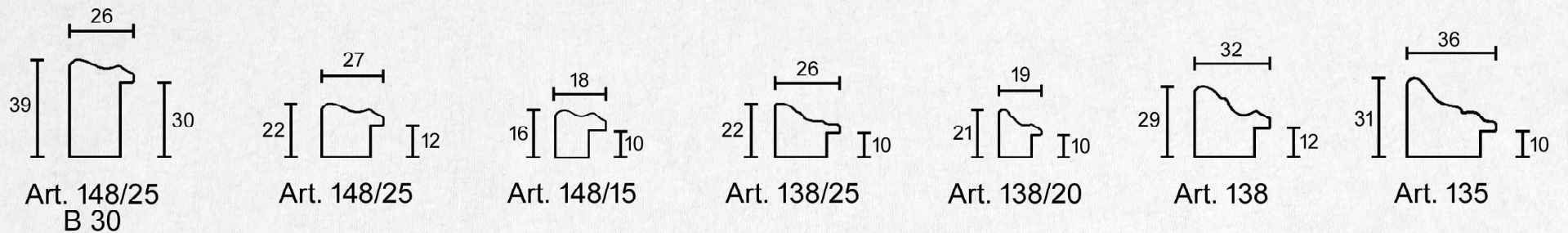
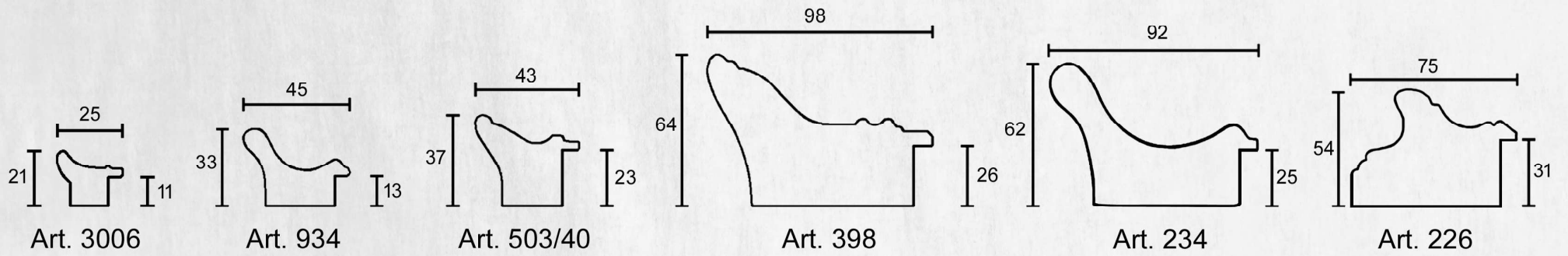

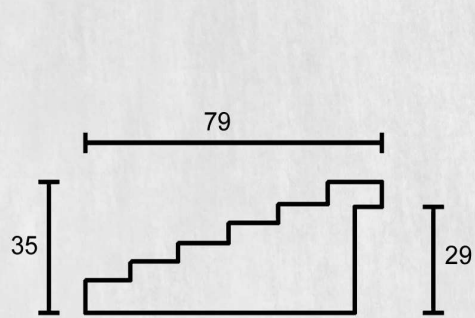

Art. 3001

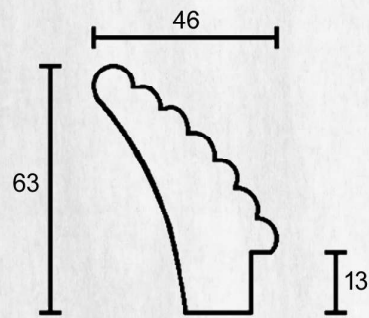

Art. 787

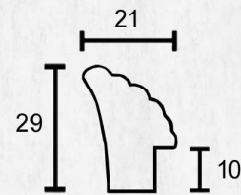

Art. 777

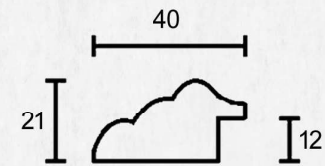

Art. 521

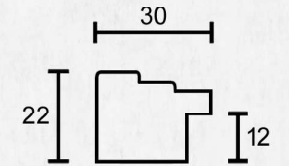

Art. 308

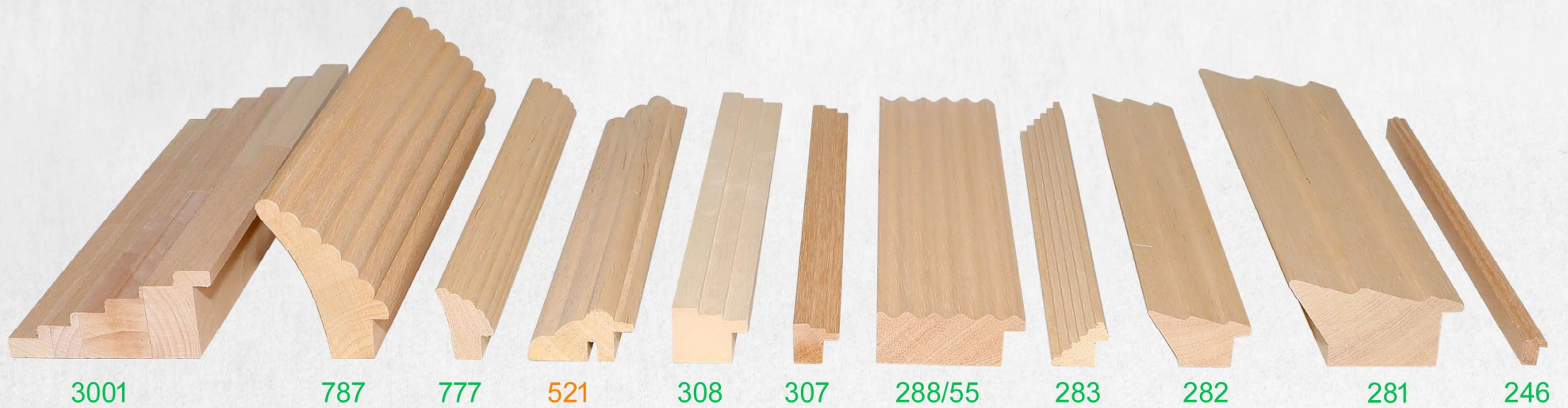

3001

787

777

521

308

307

288/55

283

282

281

246

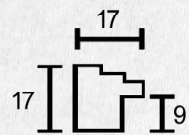

Art. 307

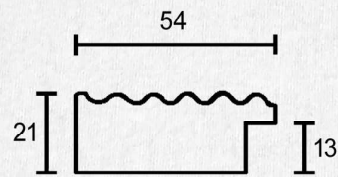

Art. 288/55

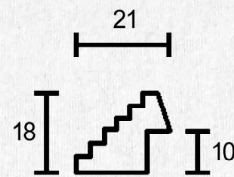

Art. 283

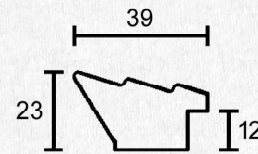

Art. 282

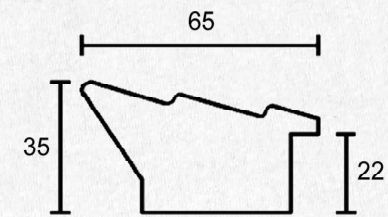

Art. 281

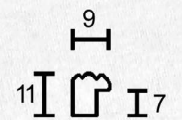

Art. 246

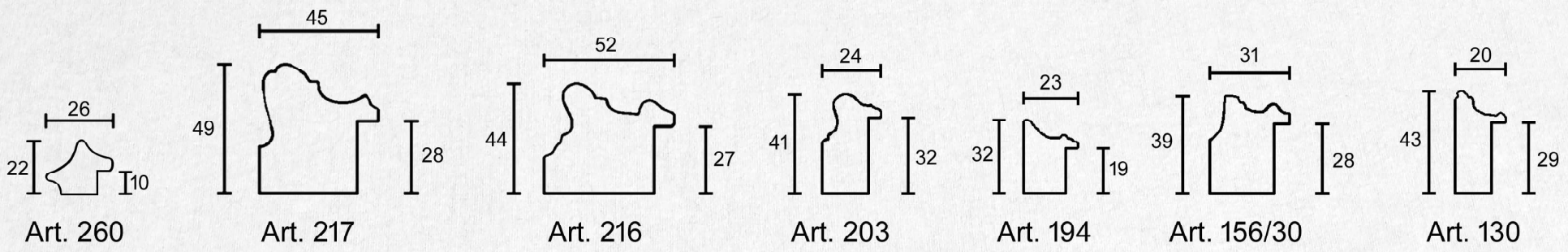
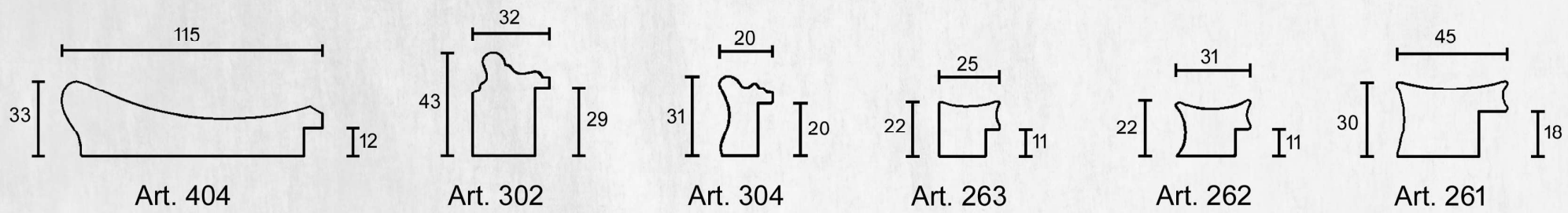

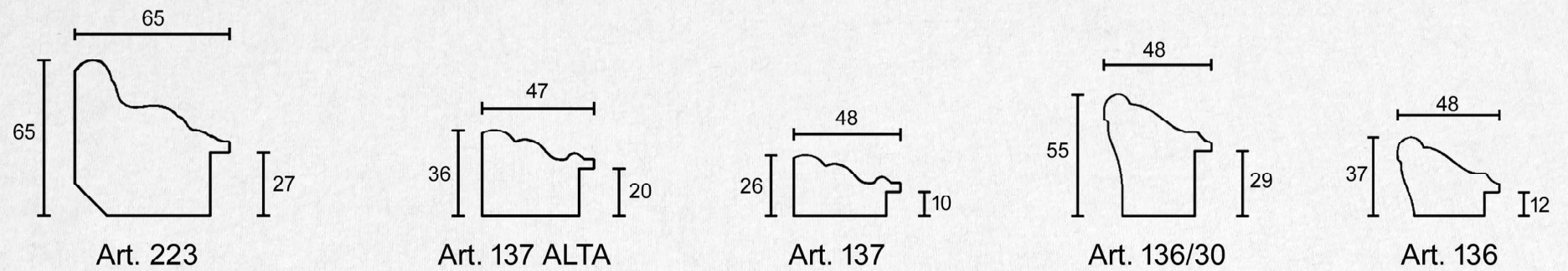
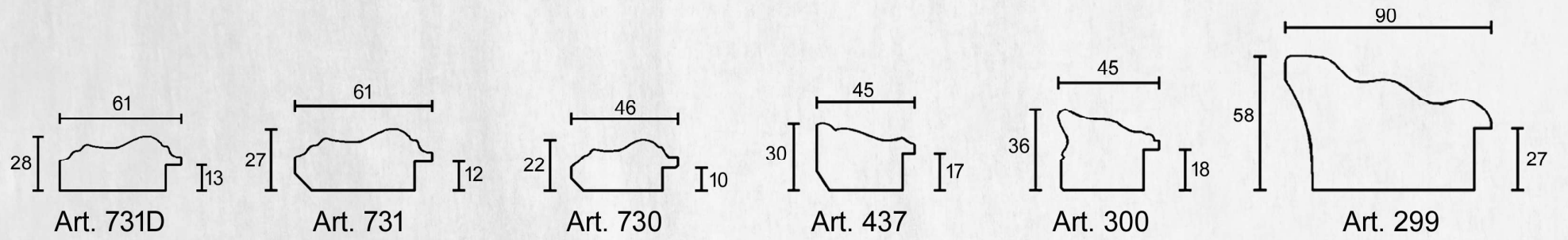

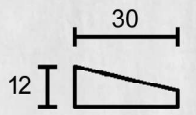

Art. DS 30

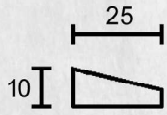

Art. DS 25

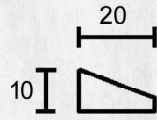

Art. DS 20

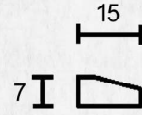

Art. DS 15

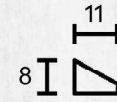

Art. DS 10

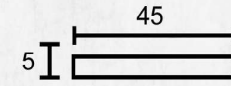

Art. D45

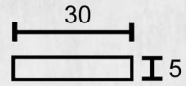

Art. D30

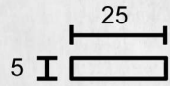

Art. D25

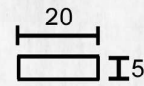

Art. D 20

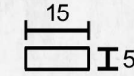

Art. D 15

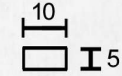

Art. D 10



Art. D 05

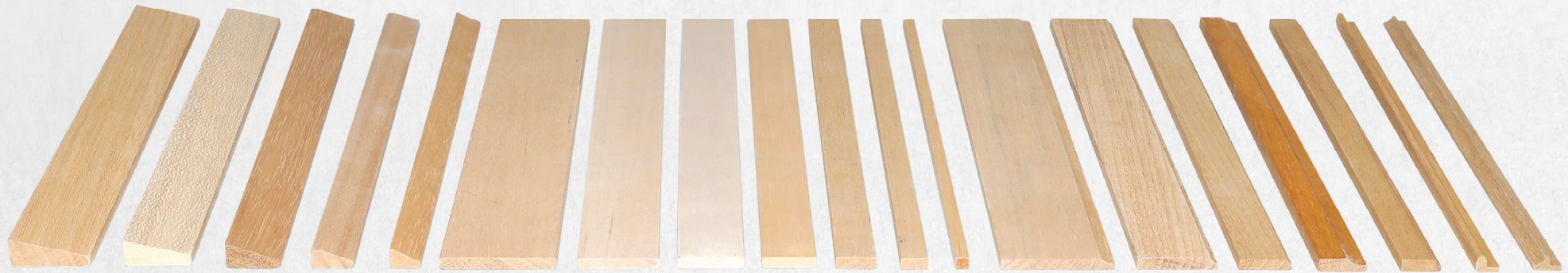

DS 30 DS 25 DS 20 DS 15 DS 10 D 45 D 30 D 25 D 20 D 15 D 10 D 05 DG 45 DG 30 DG 20 DG 20B DG 15 PIP PIP G

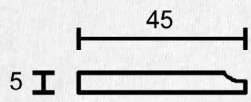

Art. DG 45

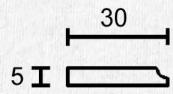

Art. DG 30

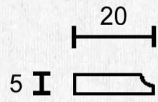

Art. DG 20

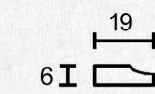

Art. DG 20B

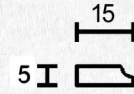

Art. DG 15

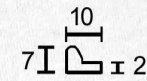

Art. PIP

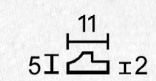

Art. PIP G

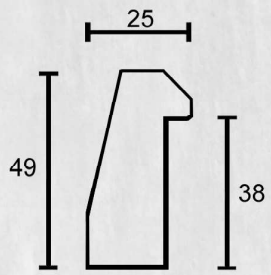

Art. 195
ROVERE

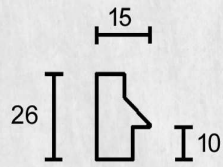

Art. 167
ROVERE

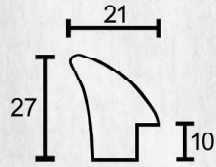

Art. 776
ROVERE

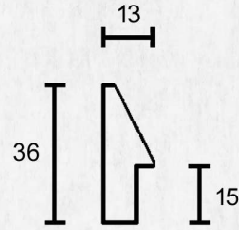

Art. 131/15
NOCE

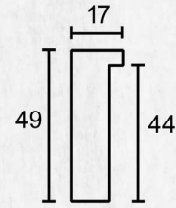

Art. 140
ROVERE

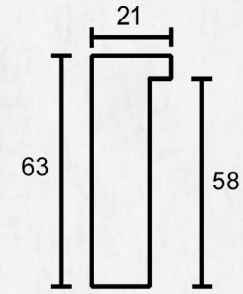

Art. 140/20x63
CILIEGIO

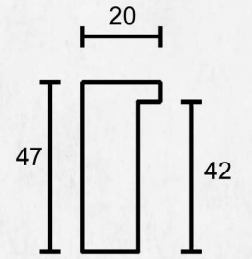

Art. 140/20x47
TULIPIER



195
ROV.

167
ROV.

776
ROV.

131/15
NOCE

140
ROV.

140/
20X63
CIL.

140/
20X47
TULIPIER

140/
15X47
D 10
TULIPIER

140/30
FAGGIO

140/30
CIL.

140/30
ROV.

140/
13x35
ROV.

140/
13x25
ROV.

116
CILIEGIO

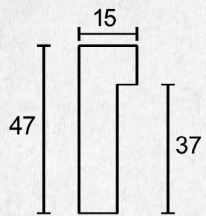

Art. 140/15x47
D 10 TULIPIER

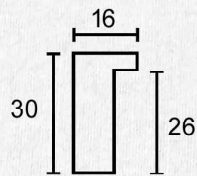

Art. 140/30
FAGGIO

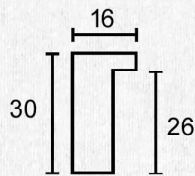

Art. 140/30
CILIEGIO

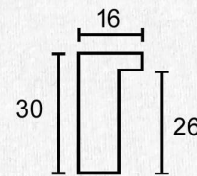

Art. 140/30
ROVERE

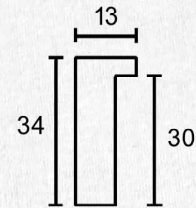

Art. 140/13x35
ROVERE

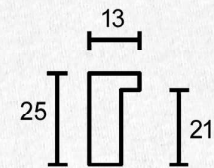

Art. 140/13x25
ROVERE

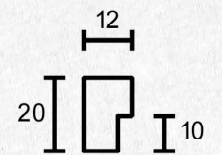

Art. 116
CILIEGIO

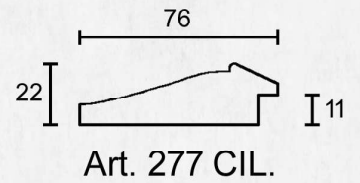
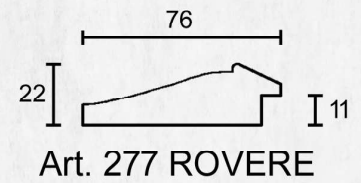
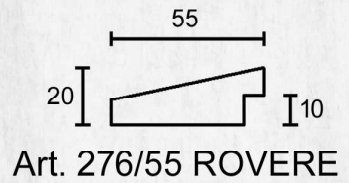
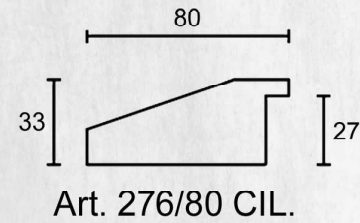
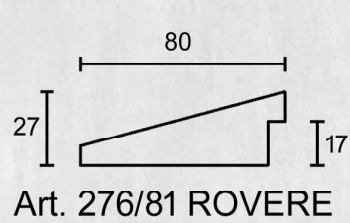

276/81
ROVERE

276/80
CIL.

276/55
ROVERE

277
ROVERE

277 CIL.

P 100x20
CILIEGINO

P 90x20
CIL.

P 50x20
ALDER

P 50x20
CIL.

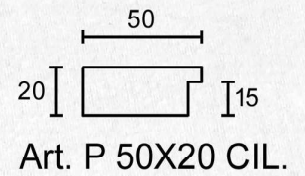
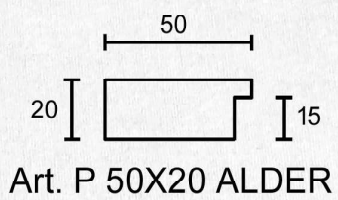
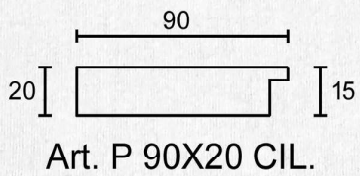
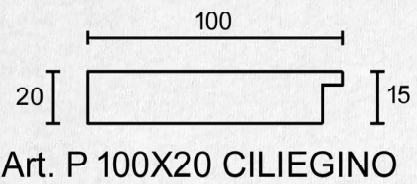

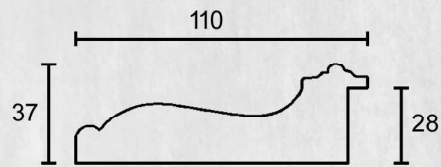

Art. 2053 CIL.

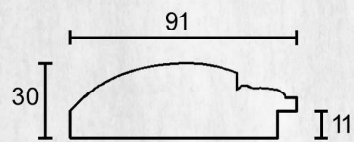

Art. 673 CIL.

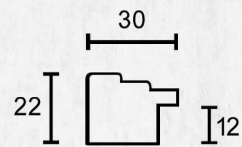

Art. 308 ROVERE

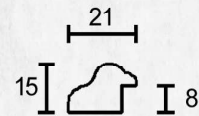

Art. 296 CIL.

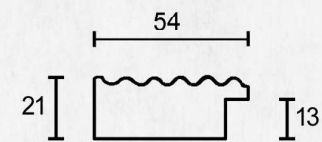

Art. 288/55 CIL.



2053 CIL.

673 CIL.

308
ROV.

296
CIL.

288/55
CIL.

288 CIL.

273 CIL.

77/60
CIL.

77/30
CIL.

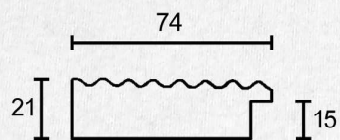

Art. 288 CIL.

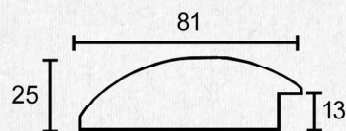

Art. 273 CIL.

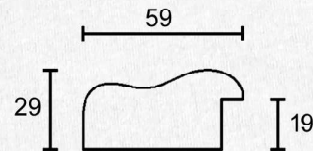

Art. 77/60 CIL.

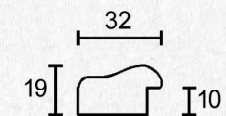

Art. 77/30 CIL.

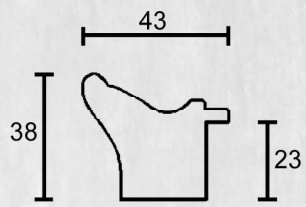

Art. 503/40 CIL.

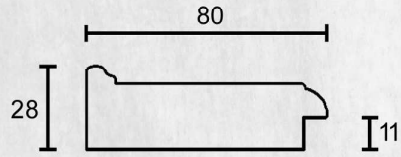

Art. 74/80 CIL.

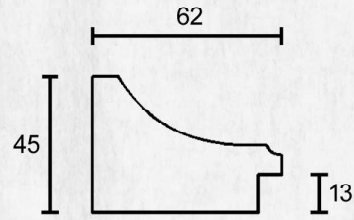

Art. 100/63 CIL.

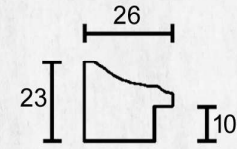

Art. 100/25 CIL.

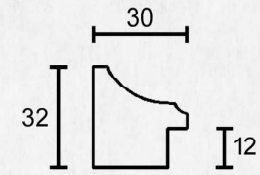

Art. 100/30 CIL.

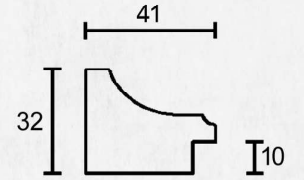

Art. 100/40 CIL.



503/40
CIL.

74/80
CIL.

100/63
CIL.

100/25
CIL.

100/30
CIL.

100/40
CIL.

252
ROV.

872
ROV.

872
CIL.

873
ROVERE

873
CILIEGIO

1072
CILIEGIO
BIANCO
OLD

1073

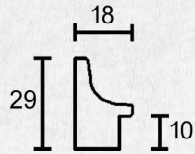

Art. 252
ROVERE

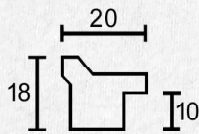

Art. 872
ROVERE

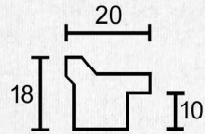

Art. 872
CILIEGIO

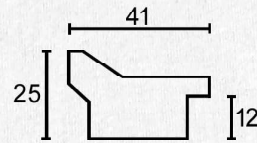

Art. 873
ROVERE

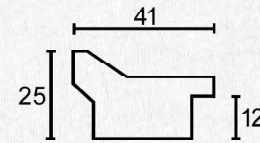

Art. 873
CILIEGIO

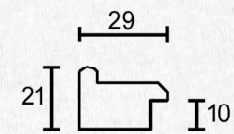

Art. 1072
CILIEGIO
BIANCO
OLD

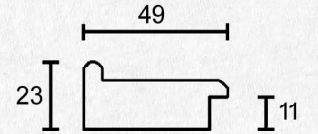

Art. 1073

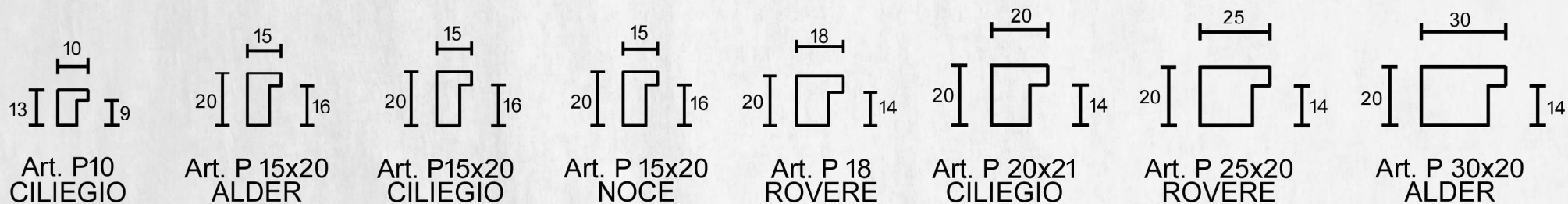

P10 CIL. P15x20 ALDER P15x20 CIL. P15x20 NOCE P18 ROV. P20x21 CIL. P25x20 ROVERE P30x20 ALDER P30x20 ROVERE P30x20 NOCE P40x20 ROVERE P40x20 CILIEGIO P40x20 NOCE P30x20 CILIEGIO

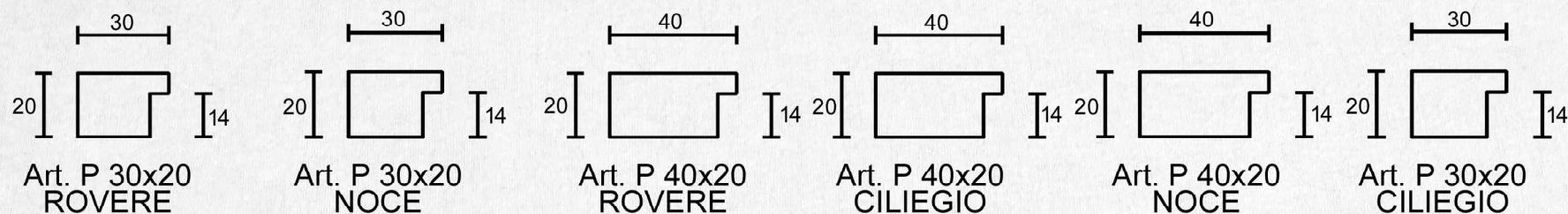

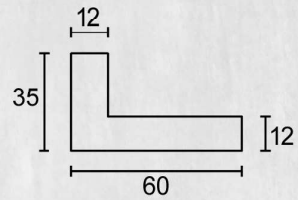

Art. L 35x60

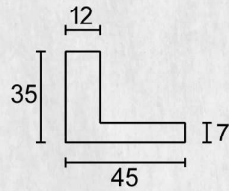

Art. L 35x45
D 12x7

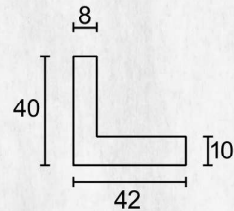

Art. L 40x40
NOCE MASS.

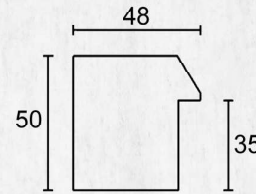

Art. PS 48x50

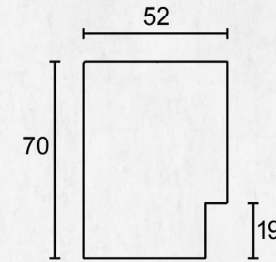

Art. 140/52x70

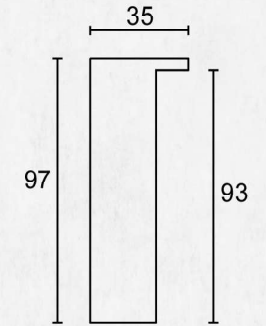

Art. 140/35x97



L 35x60

L 35x45
D12x7

L 40x40
NOCE
MASS.

PS
48x50

140/
52x70

140/
35x97

140/
25x50

140/
12x40

LISTELLO
100x15

LISTELLO
80x35

LISTELLO
50x35

LISTELLO
50x17

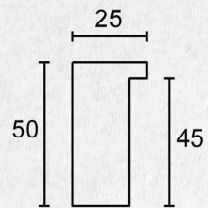

Art. 140/25x50

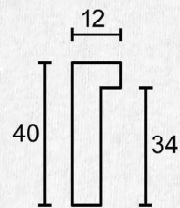

Art. 140/12x40

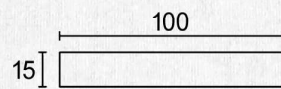

Art. LISTELLO
100x15

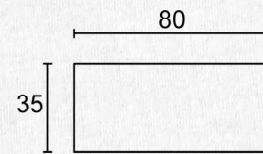

Art. LISTELLO
80x35

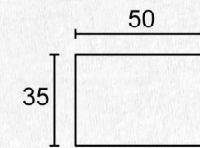

Art. LISTELLO
50x35

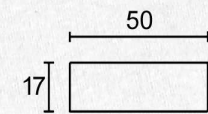

Art. LISTELLO
50x17

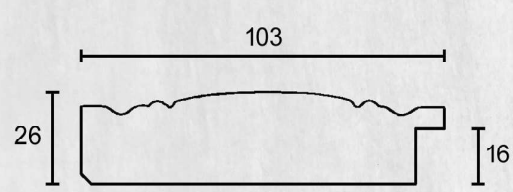

Art. 966 BASSA

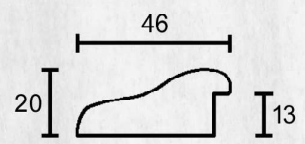

Art. 962

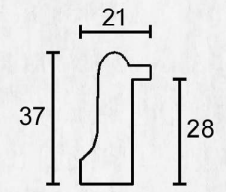

Art. 119

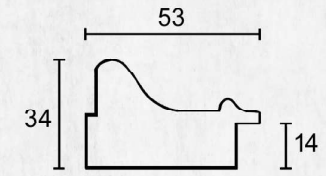

Art. 1718

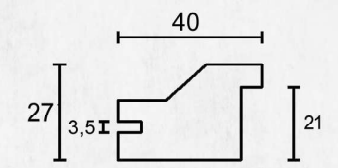

Art. P 4500

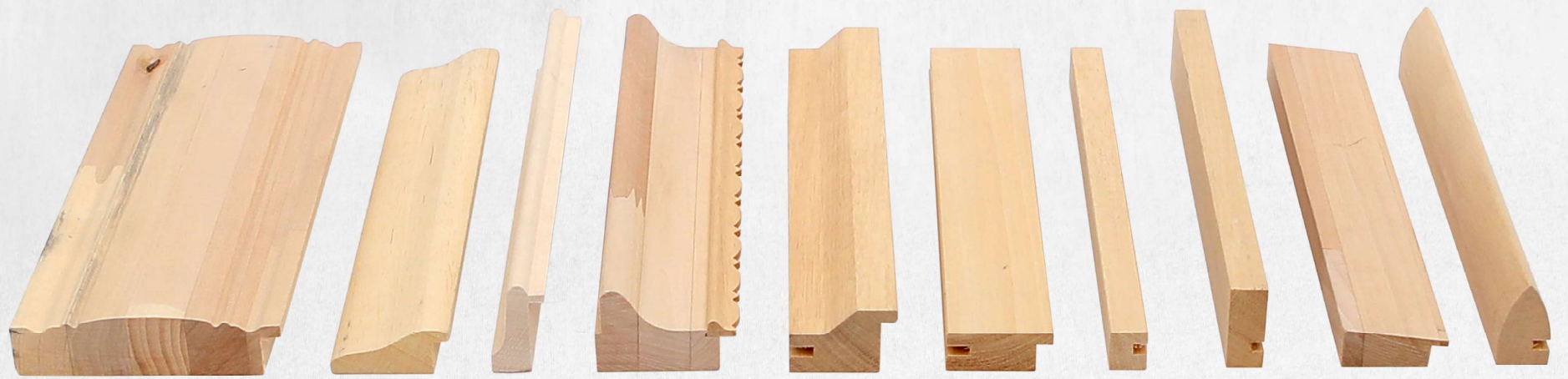

966 BASSA

962

119

1718

P 4500

P 4000

P 1000

14000

84

42700

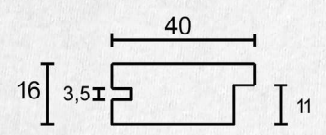

Art. P 4000

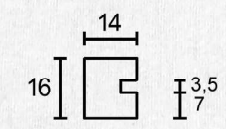

Art. P 1000

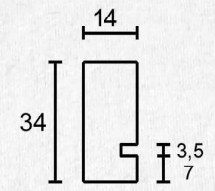

Art. 14000

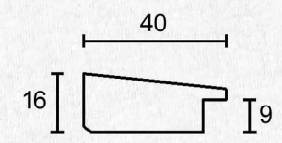

Art. 84

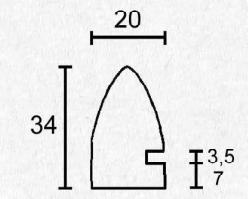

Art. 42700

INDICE

art. 67	pag. 49	art. 120	pag. 41	art. 140/30x55 GRE.	pag. 24	art. 204	pag. 49	art. 291	pag. 39
art. 70	pag. 49	art. 121	pag. 33	art. 140/35x80	pag. 32	art. 205	pag. 49	art. 293	pag. 44
art. 74 FLEX	pag. 42	art. 123	pag. 32	art. 140/35x97	pag. 61	art. 216	pag. 53	art. 296 CIL.	pag. 58
art. 74/80 CIL.	pag. 59	art. 124	pag. 32	art. 140/52x70	pag. 61	art. 217	pag. 53	art. 299	pag. 54
art. 75/35 GRECA	pag. 8	art. 125	pag. 16	art. 141	pag. 33	art. 221	pag. 50	art. 300	pag. 54
art. 75/35	pag. 42	art. 128	pag. 16	art. 141/27	pag. 33	art. 223	pag. 54	art. 302	pag. 53
art. 77/30 CIL.	pag. 58	art. 130	pag. 53	art. 142	pag. 32	art. 224	pag. 39	art. 304	pag. 53
art. 77/30 TORT.	pag. 23	art. 131	pag. 34	art. 146 TORT.	pag. 16	art. 224/55	pag. 38	art. 307	pag. 52
art. 77/60 CIL.	pag. 58	art. 131/15 NOCE	pag. 56	art. 146	pag. 32	art. 225	pag. 38	art. 308 ROV.	pag. 58
art. 78	pag. 35	art. 131/15	pag. 34	art. 148/15	pag. 51	art. 226	pag. 51	art. 308	pag. 52
art. 79N BATT. 27	pag. 35	art. 131/30	pag. 34	art. 148/25 B.30	pag. 51	art. 233	pag. 45	art. 309	pag. 42
art. 79N	pag. 35	art. 131/36	pag. 34	art. 148/25	pag. 51	art. 234	pag. 51	art. 310	pag. 39
art. 83 FLEX	pag. 24	art. 131/51	pag. 34	art. 149	pag. 38	art. 240	pag. 49	art. 320	pag. 39
art. 83	pag. 35	art. 131/60x25	pag. 34	art. 154	pag. 31	art. 241	pag. 49	art. 327	pag. 50
art. 84	pag. 62	art. 131/60x27	pag. 37	art. 154/40	pag. 31	art. 244	pag. 47	art. 328	pag. 38
art. 100/25 CIL.	pag. 59	art. 131/66	pag. 34	art. 154/50 ALTA	pag. 31	art. 245	pag. 41	art. 330	pag. 38
art. 100/30 CIL.	pag. 59	art. 135	pag. 51	art. 154/50	pag. 31	art. 245/20	pag. 41	art. 331	pag. 38
art. 100/40 CIL.	pag. 59	art. 136	pag. 54	art. 156/30	pag. 53	art. 246	pag. 52	art. 332	pag. 39
art. 100/40	pag. 41	art. 136/30	pag. 54	art. 160	pag. 23	art. 251	pag. 25	art. 335	pag. 49
art. 100/60	pag. 40	art. 137 ALTA	pag. 54	art. 162	pag. 49	art. 252 ROV.	pag. 59	art. 336	pag. 49
art. 100/63 CIL.	pag. 59	art. 137	pag. 54	art. 164	pag. 34	art. 252	pag. 41	art. 353	pag. 8
art. 101 GOYA	pag. 45	art. 138	pag. 51	art. 167 ROVERE	pag. 56	art. 260	pag. 53	art. 355	pag. 40
art. 101	pag. 45	art. 138/20	pag. 51	art. 167	pag. 34	art. 261	pag. 53	art. 371	pag. 44
art. 101/30	pag. 45	art. 138/25	pag. 51	art. 167/20	pag. 34	art. 262	pag. 53	art. 371/30	pag. 44
art. 102	pag. 45	art. 139	pag. 44	art. 168	pag. 36	art. 263	pag. 53	art. 379	pag. 43
art. 102/20	pag. 45	art. 140 ROVERE	pag. 56	art. 169	pag. 35	art. 267 GUILL.	pag. 23	art. 380 W	pag. 7
art. 102 T	pag. 45	art. 140	pag. 33	art. 170 B.30	pag. 35	art. 270	pag. 5	art. 390	pag. 43
art. 103 A	pag. 45	art. 140/7x22	pag. 33	art. 170	pag. 35	art. 271	pag. 49	art. 398	pag. 51
art. 103 GRECA	pag. 16	art. 140/8x35	pag. 33	art. 171	pag. 35	art. 273 CILIEGIO	pag. 58	art. 401	pag. 38
art. 103	pag. 45	art. 140/10x40	pag. 32	art. 172	pag. 42	art. 273	pag. 46	art. 402	pag. 38
art. 103/30	pag. 45	art. 140/12x40	pag. 61	art. 174	pag. 36	art. 275	pag. 45	art. 403	pag. 40
art. 104 T ALTA	pag. 45	art. 140/13x25 ROV.	pag. 56	art. 176	pag. 21	art. 276/35	pag. 37	art. 404	pag. 53
art. 104	pag. 45	art. 140/13x34 ROV.	pag. 56	art. 183	pag. 35	art. 276/55 ROV.	pag. 57	art. 407	pag. 10
art. 105 G	pag. 46	art. 140/13x34	pag. 33	art. 184	pag. 34	art. 276/60	pag. 37	art. 409	pag. 10
art. 105	pag. 46	art. 140/15x47 D10 TULIP.	pag. 56	art. 185	pag. 33	art. 276/80 CIL.	pag. 57	art. 410	pag. 40
art. 107	pag. 42	art. 140/20x28 GRE.	pag. 24	art. 190	pag. 23	art. 276/80	pag. 37	art. 413	pag. 31
art. 108	pag. 37	art. 140/20x40	pag. 33	art. 191	pag. 35	art. 276/81 ROV.	pag. 57	art. 415	pag. 47
art. 111	pag. 41	art. 140/20x47 TULIPIER	pag. 56	art. 192	pag. 37	art. 277 CILIEGIO	pag. 57	art. 415/48	pag. 47
art. 111/30	pag. 41	art. 140/20x50	pag. 33	art. 194	pag. 37	art. 277 ROVERE	pag. 57	art. 419	pag. 41
art. 113	pag. 31	art. 140/20x55	pag. 33	art. 195 ROVERE	pag. 56	art. 277	pag. 37	art. 423	pag. 41
art. 114	pag. 45	art. 140/20x63 CIL.	pag. 56	art. 195	pag. 32	art. 280	pag. 5	art. 424	pag. 41
art. 115	pag. 32	art. 140/25x35	pag. 33	art. 196	pag. 50	art. 281	pag. 52	art. 425	pag. 5
art. 116 CIL.	pag. 56	art. 140/25x50 GRE.	pag. 24	art. 197	pag. 50	art. 282	pag. 52	art. 430	pag. 49
art. 116	pag. 32	art. 140/25x50	pag. 61	art. 201	pag. 47	art. 283	pag. 52	art. 434	pag. 9
art. 119	pag. 62	art. 140/30 CILIEGIO	pag. 56	art. 201 B	pag. 47	art. 288 CIL.	pag. 58	art. 435	pag. 9
		art. 140/30 FAGGIO	pag. 56	art. 202	pag. 44	art. 288/55 CIL.	pag. 58	art. 437	pag. 54
		art. 140/30 ROVERE	pag. 56	art. 202 N	pag. 44	art. 288/55	pag. 52	art. 445	pag. 18
		art. 140/30	pag. 33	art. 203	pag. 53	art. 290	pag. 39		

art. 906/30	pag. 1	art. 997	pag. 48	art. D 10	pag. 55	art. P 15X20 CIL.	pag. 60	art. P 110	pag. 27
art. 907	pag. 12	art. 998	pag. 48	art. D 15	pag. 55	art. P 15X20 NOCE	pag. 60	art. P 110X25	pag. 27
art. 909 BASE	pag. 32	art. 999	pag. 9	art. D 20	pag. 55	art. P 16 GOYA	pag. 44	art. P 1000	pag. 62
art. 909 LIST.	pag. 3	art. 1013	pag. 46	art. D 25	pag. 55	art. P 16	pag. 44	art. P 4000	pag. 62
art. 909 LIST. B	pag. 3	art. 1014	pag. 46	art. D 30	pag. 55	art. P 18 ROV.	pag. 60	art. P 4500	pag. 62
art. 910	pag. 12	art. 1072 CIL.B.CO OLD	pag. 59	art. D 45	pag. 55	art. P 20 APR.	pag. 24	art. P 4500	pag. 62
art. 910/40	pag. 12	art. 1073	pag. 59	art. DG 15	pag. 55	art. P 20 FLEX	pag. 24	art. PASS 200	pag. 48
art. 912	pag. 41	art. 1080	pag. 6	art. DG 20	pag. 55	art. P 20	pag. 28	art. PG 2/40	pag. 31
art. 916	pag. 7	art. 1084	pag. 50	art. DG 20 B	pag. 55	art. P 20X18 TIGLIO	pag. 28	art. PG 10	pag. 29
art. 920 ALTA	pag. 9	art. 1101	pag. 48	art. DG 30	pag. 55	art. P 20X20	pag. 27	art. PG 15	pag. 29
art. 920	pag. 9	art. 1102	pag. 48	art. DG 45	pag. 55	art. P 20X21 CIL.	pag. 60	art. PG 20	pag. 29
art. 921	pag. 50	art. 1103	pag. 48	art. DS 10	pag. 55	art. P 25	pag. 28	art. PG 22	pag. 30
art. 922	pag. 40	art. 1104	pag. 50	art. DS 15	pag. 55	art. P 25X20 ROV.	pag. 60	art. PG 25 B	pag. 29
art. 923	pag. 48	art. 1163	pag. 36	art. DS 20	pag. 55	art. P 26	pag. 44	art. PG 30	pag. 29
art. 925	pag. 22	art. 1164	pag. 36	art. DS 25	pag. 55	art. P 30 APR.	pag. 24	art. PG 30 B	pag. 29
art. 926	pag. 47	art. 1166	pag. 37	art. DS 30	pag. 55	art. P 30	pag. 28	art. PG 34	pag. 30
art. 927	pag. 47	art. 1167	pag. 37	art. L 30X30 4X8	pag. 25	art. P 30X20 ALDER	pag. 60	art. PG 35 B	pag. 29
art. 927 RUS.	pag. 24	art. 1201	pag. 13	art. L 30X30 4X8 ROV.	pag. 25	art. P 30X20 CIL.	pag. 60	art. PG 40	pag. 29
art. 928	pag. 16	art. 1220	pag. 6	art. L 34X45 D 12X7	pag. 61	art. P 30X20 NOCE	pag. 60	art. PG 40B	pag. 29
art. 934	pag. 51	art. 1221	pag. 22	art. L 35X45	pag. 25	art. P 30X20 ROV.	pag. 60	art. PG 41	pag. 30
art. 937	pag. 3	art. 1601	pag. 40	art. L 35X60	pag. 61	art. P 30X28 GRE	pag. 24	art. PG 44	pag. 30
art. 938	pag. 32	art. 1672	pag. 4	art. L 40X40 NOCE MASS.	pag. 61	art. P 30X30 D15	pag. 27	art. PG 45	pag. 45
art. 940/50	pag. 49	art. 1696	pag. 10	art. L 40X40 ROV.	pag. 25	art. P 30X30	pag. 27	art. PG 45 B	pag. 29
art. 944	pag. 46	art. 1697	pag. 10	art. L 45X50	pag. 25	art. P 34X35	pag. 31	art. PG 46	pag. 30
art. 945	pag. 12	art. 1718	pag. 62	art. L 45X65	pag. 25	art. P 35X25	pag. 27	art. PG 50	pag. 29
art. 947	pag. 22	art. 1738	pag. 23	art. LISTELLO 10X10	pag. 26	art. P 36	pag. 44	art. PG 51	pag. 30
art. 948	pag. 22	art. 1897	pag. 2	art. LISTELLO 15X10	pag. 26	art. P 40 FLEX	pag. 24	art. PG 55	pag. 29
art. 950	pag. 11	art. 1898	pag. 2	art. LIST. 18X15 AYOUS	pag. 26	art. P 40	pag. 28	art. PIP G	pag. 55
art. 955	pag. 18	art. 1899	pag. 2	art. LISTELLO 20X10	pag. 26	art. P 40X18 TIGLIO	pag. 28	art. PIP	pag. 55
art. 956	pag. 17	art. 2050	pag. 39	art. LISTELLO 30X15	pag. 26	art. P 40X20 CIL.	pag. 60	art. PIP 702	pag. 14
art. 960	pag. 3	art. 2052	pag. 38	art. LISTELLO 45X45	pag. 26	art. P 40X20 NOCE	pag. 60	art. PR 25	pag. 23
art. 961	pag. 3	art. 2053 CILIEGIO	pag. 58	art. LISTELLO 50X12	pag. 26	art. P 40X20 ROV	pag. 60	art. PR 45	pag. 23
art. 962	pag. 62	art. 2053	pag. 38	art. LISTELLO 50X15	pag. 26	art. P 45	pag. 28	art. PS 21	pag. 30
art. 963	pag. 3	art. 2054	pag. 39	art. LISTELLO 50X17	pag. 61	art. P 45X35	pag. 27	art. PS 31	pag. 30
art. 966 BASSA	pag. 62	art. 2055	pag. 39	art. LISTELLO 50X20	pag. 26	art. P 50	pag. 28	art. PS 41 APR.	pag. 24
art. 969	pag. 10	art. 3001	pag. 52	art. LISTELLO 50X35	pag. 61	art. P 50X20 ALDER	pag. 57	art. PS 41	pag. 30
art. 971	pag. 36	art. 3002	pag. 38	art. LISTELLO 60X20	pag. 26	art. P 50X20 CIL.	pag. 57	art. PS 44	pag. 30
art. 972	pag. 36	art. 3003	pag. 39	art. LISTELLO 60X25	pag. 26	art. P 50X38 GRE.	pag. 24	art. PS 45/35	pag. 30
art. 973	pag. 36	art. 3006	pag. 51	art. LISTELLO 80X15	pag. 26	art. P 55	pag. 28	art. PS 48X50	pag. 61
art. 976	pag. 1	art. 5020	pag. 28	art. LISTELLO 80X20	pag. 26	art. P 55X25	pag. 27	art. PS 50	pag. 30
art. 979	pag. 10	art. 14000	pag. 62	art. LISTELLO 80X35	pag. 61	art. P 56	pag. 27	art. PS 50X11	pag. 30
art. 981	pag. 3	art. 41030	pag. 49	art. LISTELLO 100X15	pag. 61	art. P 60	pag. 28	art. PS 60	pag. 30
art. 984	pag. 49	art. 41415	pag. 47	art. LISTELLO 100X20	pag. 26	art. P 64X35	pag. 31	art. PS 90	pag. 30
art. 985	pag. 6	art. 42060	pag. 3	art. MULA	pag. 50	art. P 70	pag. 28	art. RIALZO 25	pag. 26
art. 990	pag. 12	art. 42065	pag. 3	art. P 10 CIL.	pag. 60	art. P 90	pag. 28	art. RIALZO 45	pag. 26
art. 993	pag. 12	art. 42070	pag. 3	art. P 10	pag. 28	art. P 90X20 CIL.	pag. 57	art. SOLE 5	pag. 36
art. 995	pag. 22	art. 42700	pag. 62	art. P 15	pag. 28	art. P 95X25	pag. 27	art. TELAIO DS50	pag. 26
art. 996	pag. 47	art. D05	pag. 55	art. P 15X20 ALDER	pag. 60	art. P 100X20 CILIEGINO	pag. 57		

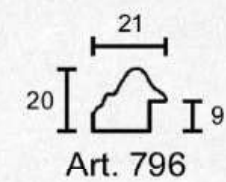
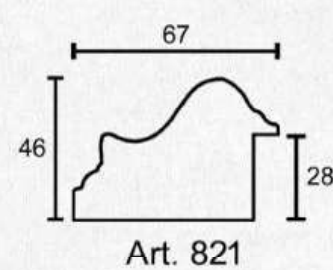
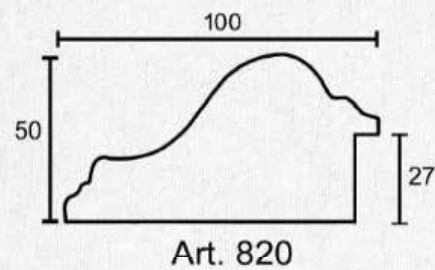
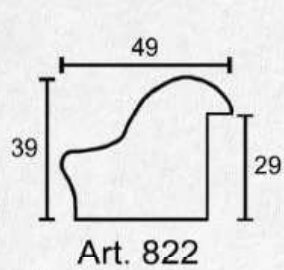
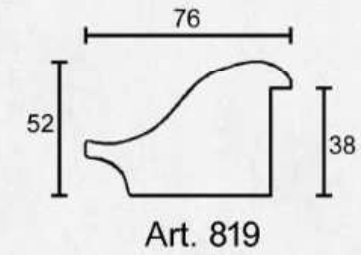
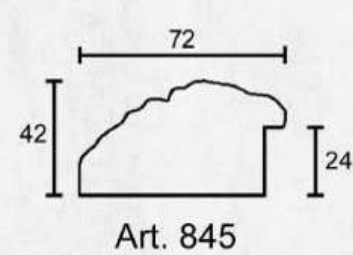
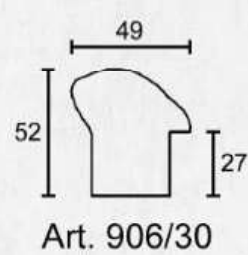
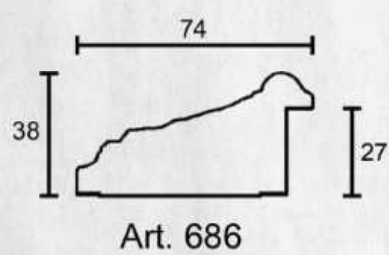
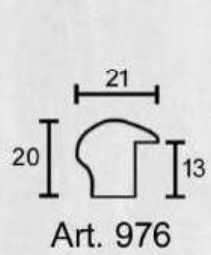

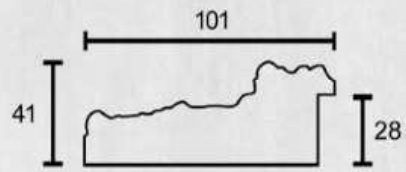

Art. 699

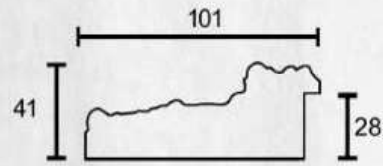

Art. 799

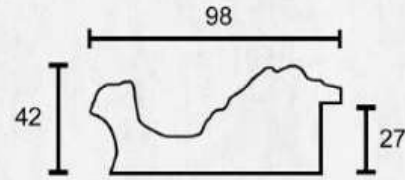

Art. 1899

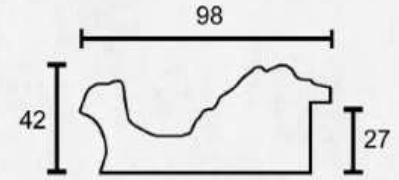

Art. 899



699

799

1899

899

897

898

1898

1897

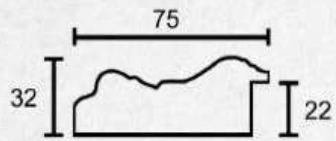

Art. 897

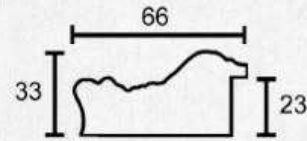

Art. 898

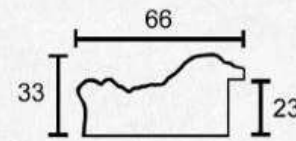

Art. 1898

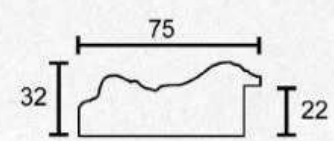

Art. 1897

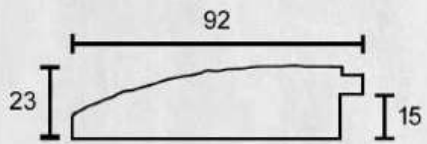

Art. 937

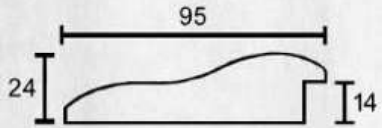

Art. 960

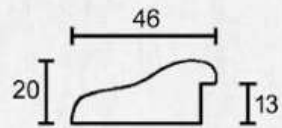

Art. 961

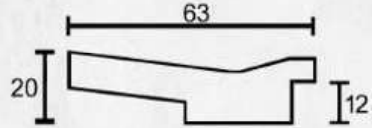

Art. 963

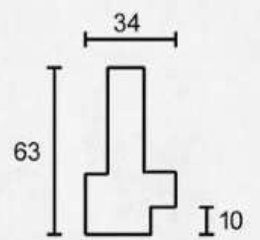

Art. 42065



937

960

961

963

42065

42060

42070

981

909 LIST. B.

909 LIST.

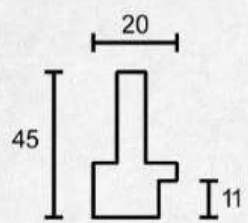

Art. 42060

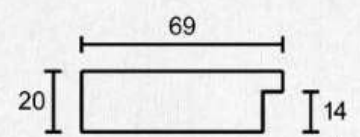

Art. 42070

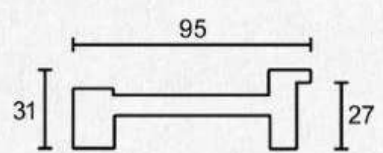

Art. 981

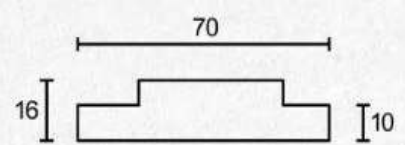

Art. 909 LIST. B.

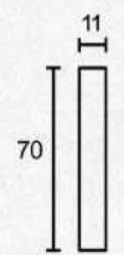

Art. 909 LIST.

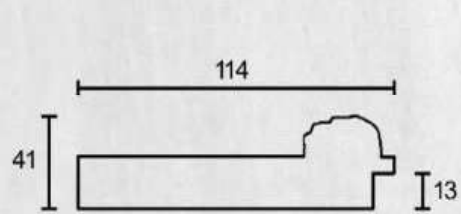

Art. 1672

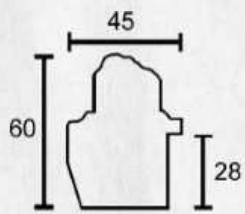

Art. 672 ALTA

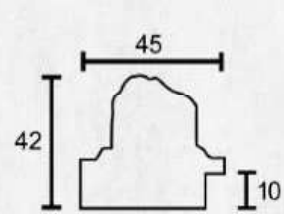

Art. 672

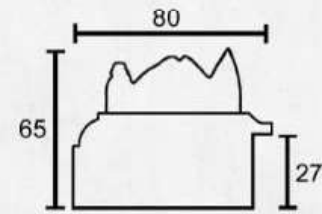

Art. 671 ALTA



1672

672 ALTA

672

671 ALTA

671

571

572

846

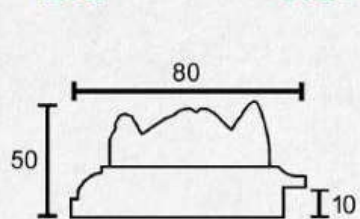

Art. 671

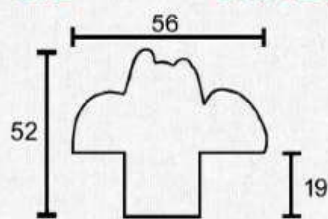

Art. 571

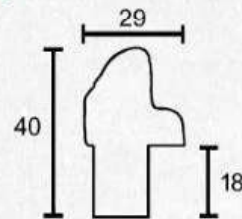

Art. 572

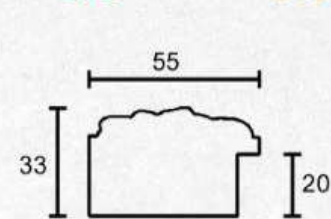

Art. 846

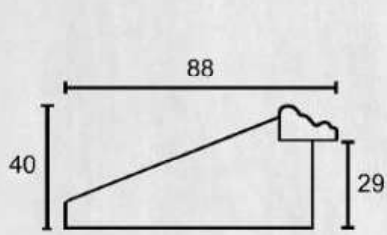

Art. 280

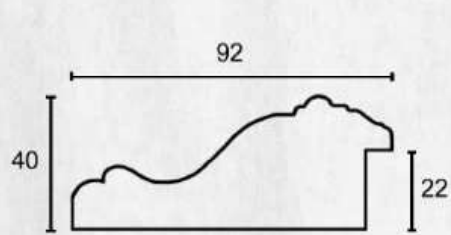

Art. 425

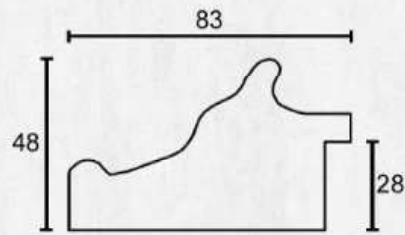

Art. 656

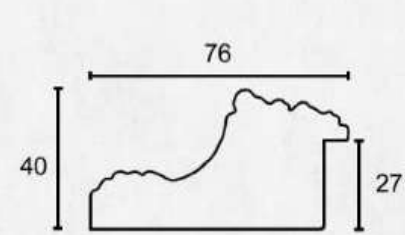

Art. 270



280

425

656

270

780

655

745

719

718

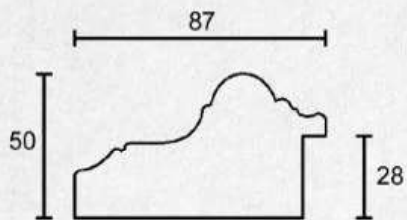

Art. 780

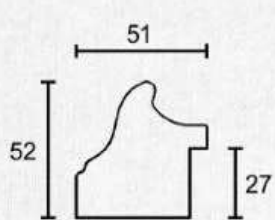

Art. 655

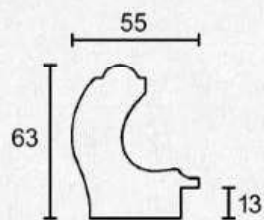

Art. 745

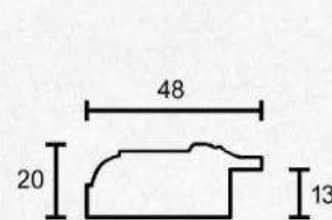

Art. 719

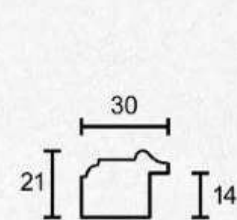

Art. 718

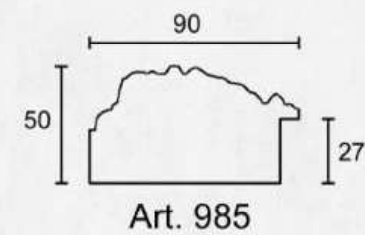
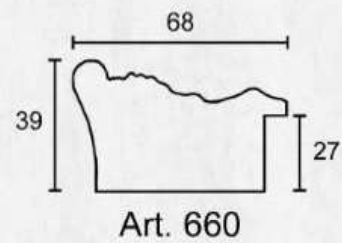
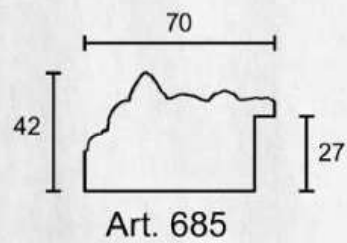
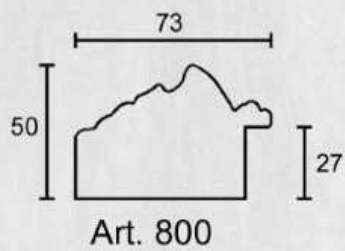

800



685



660



985



669



1080



687



1220

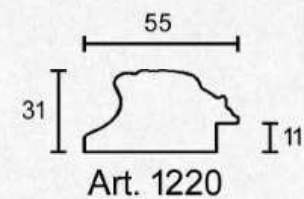
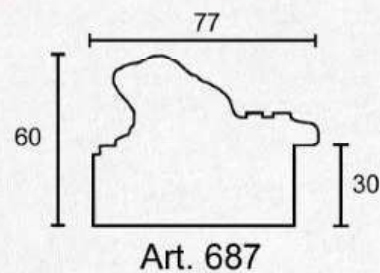
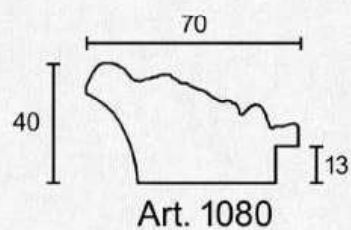
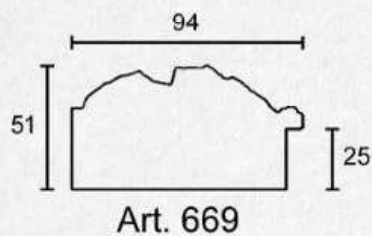

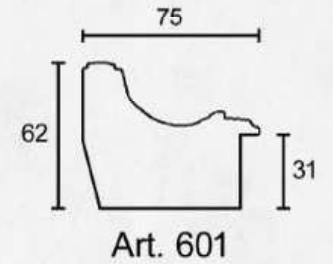
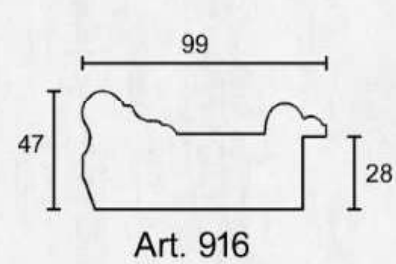
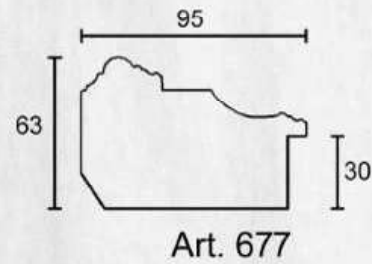
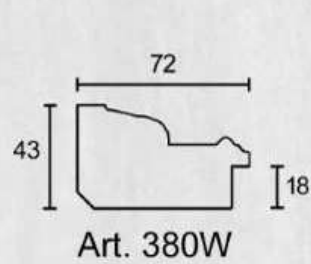

380 W

677

916

601

835

871

662

663

628

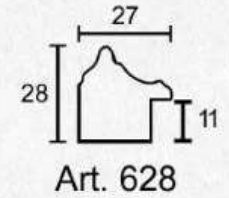
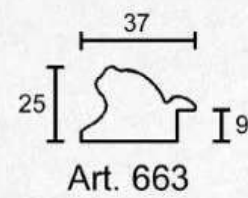
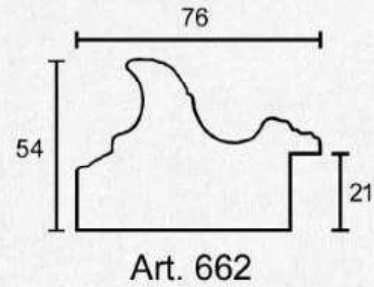
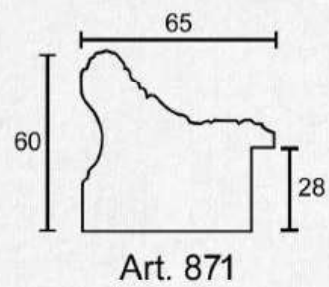
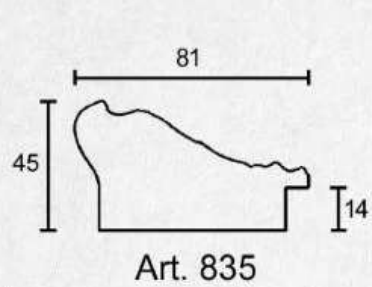

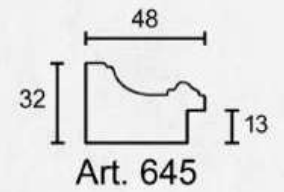
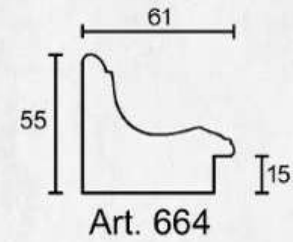
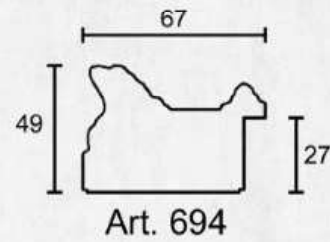
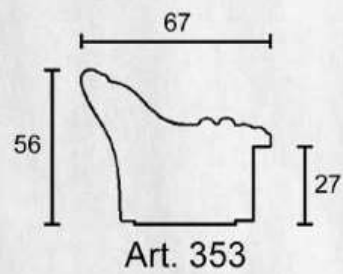
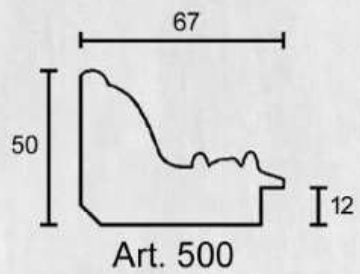

500

353

694

664

645

744

535

618

75/30
GRECA

743

743 P

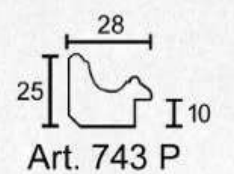
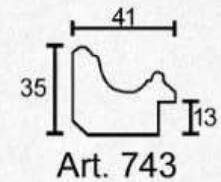
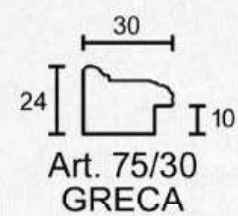
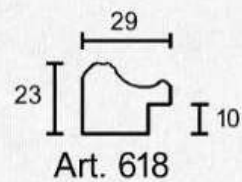
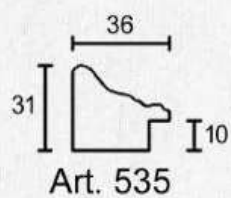
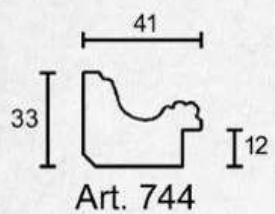

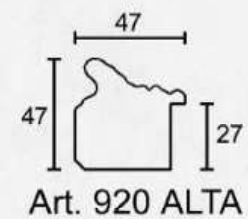
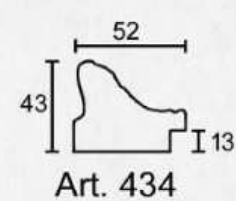
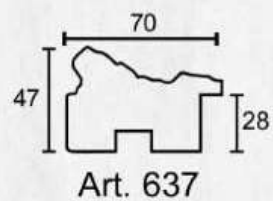
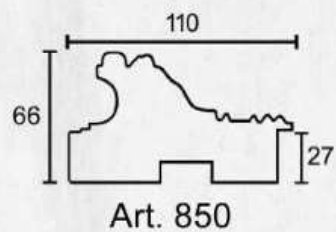
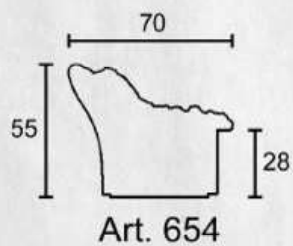
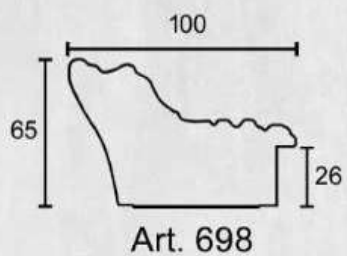

698

654

850

637

434

920
ALTA

920

999

435

726
ALTA

726

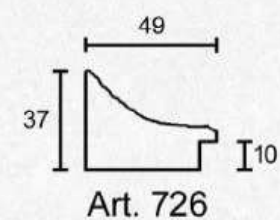
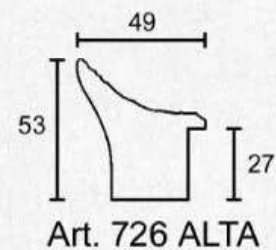
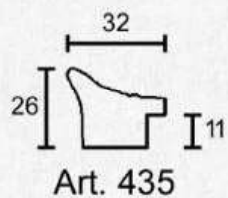
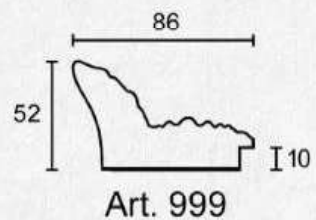
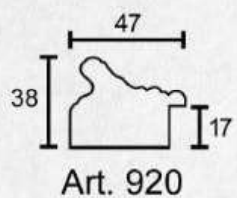

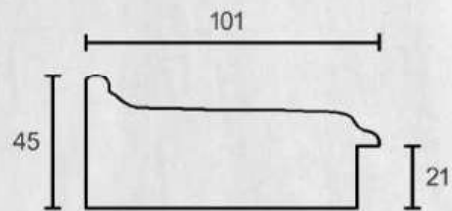

Art. 696/20

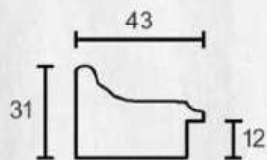

Art. 1696

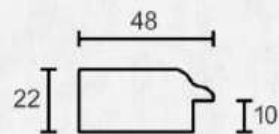

Art. 1697

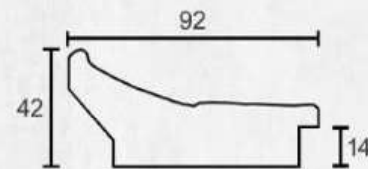

Art. 828

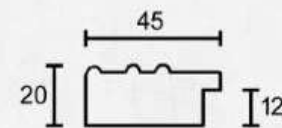

Art. 829



696/20

1696

1697

828

829

827

969

979

469

407

409

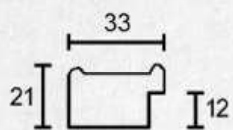

Art. 827

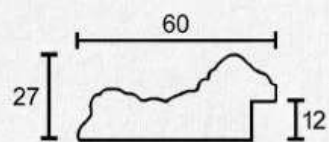

Art. 969

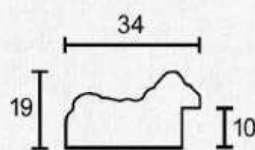

Art. 979

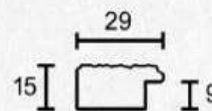

Art. 469

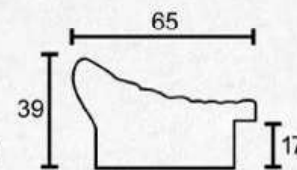

Art. 407

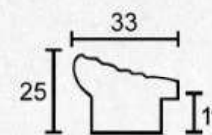

Art. 409

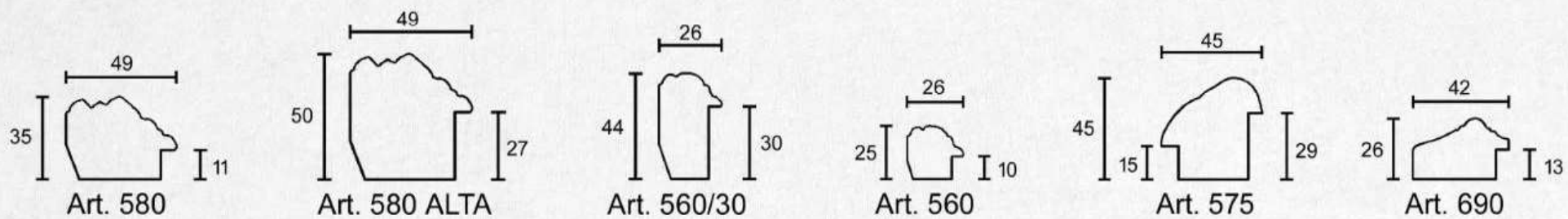
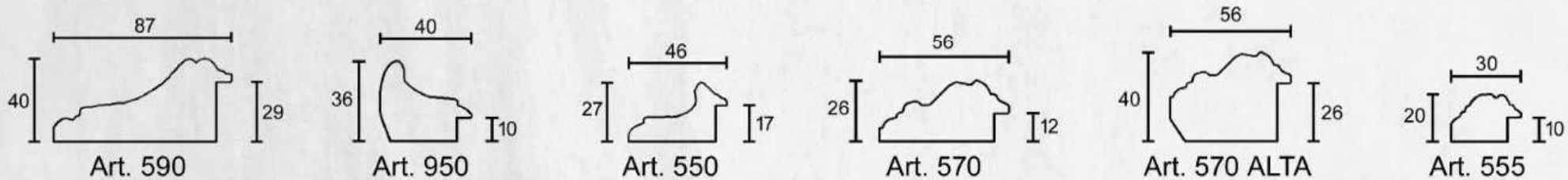

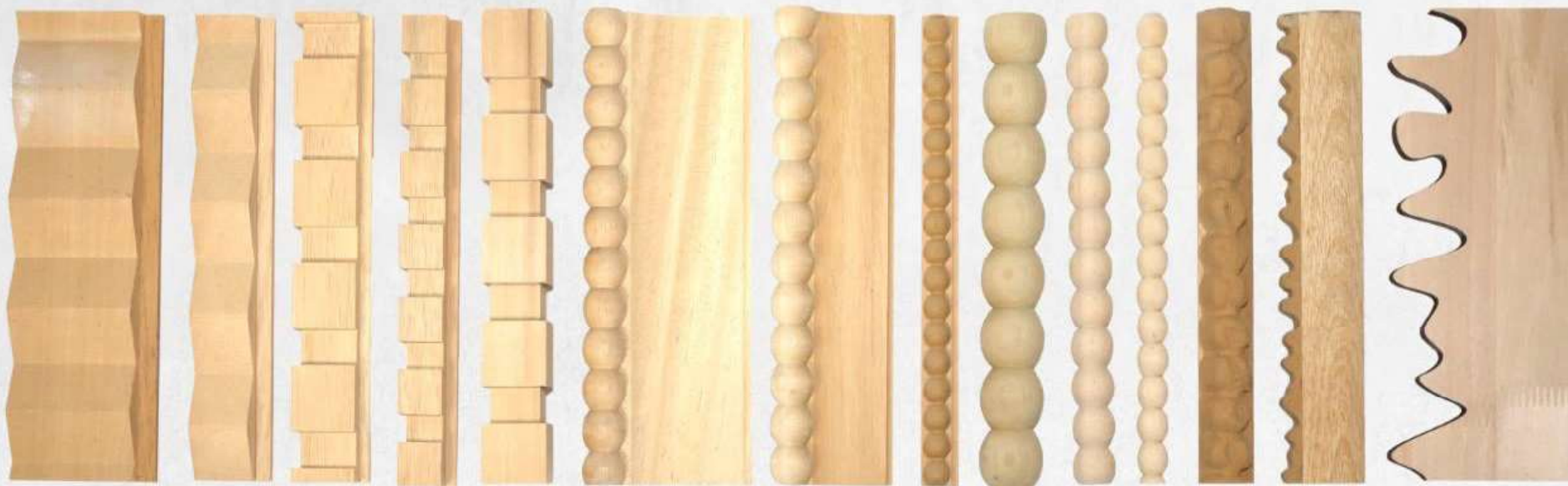
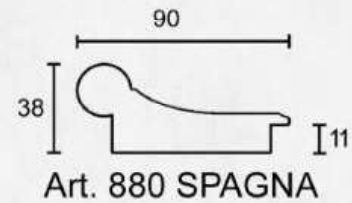
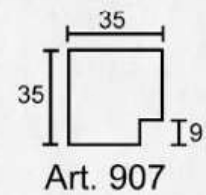
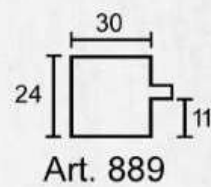
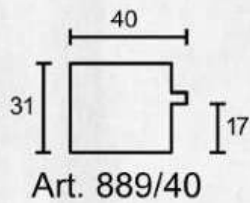
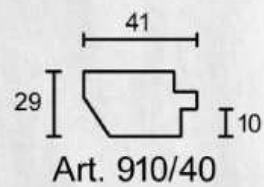
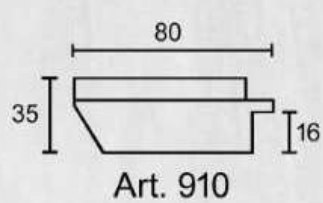

910

910/40

889/40

889

907

880
SPAGNA

880

945

890

888

886

887

993

990

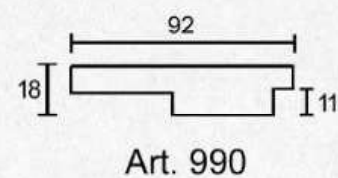
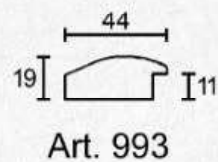
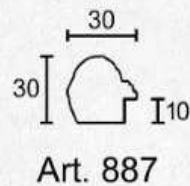
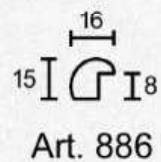
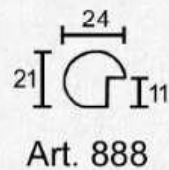
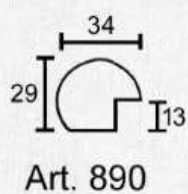
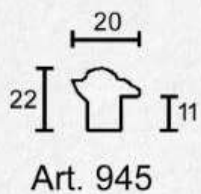
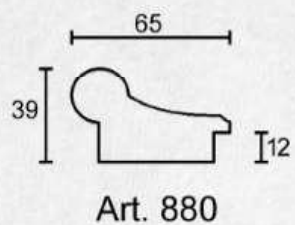

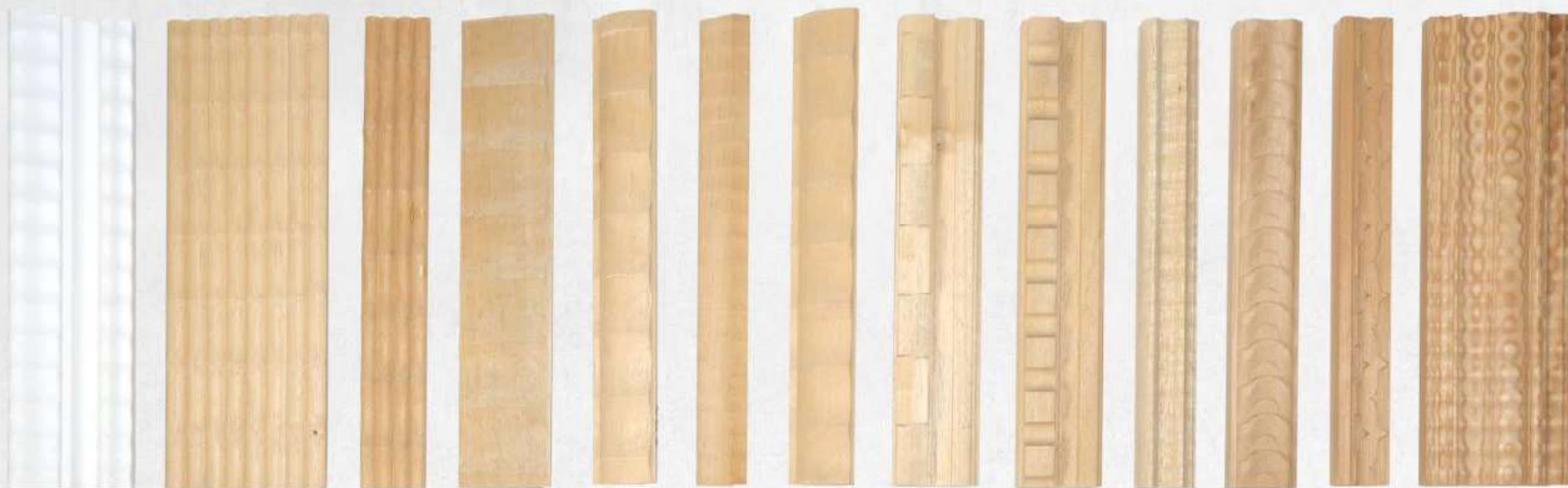
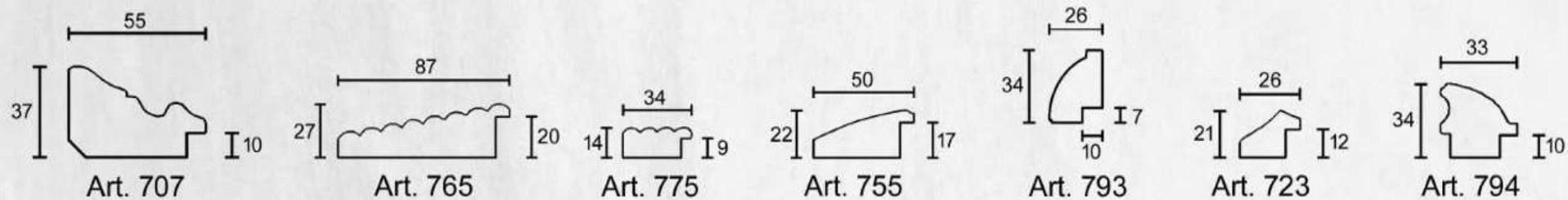

707 765 775 755 793 723 794 638 MOD. 638 DECO 714 1201 761 715

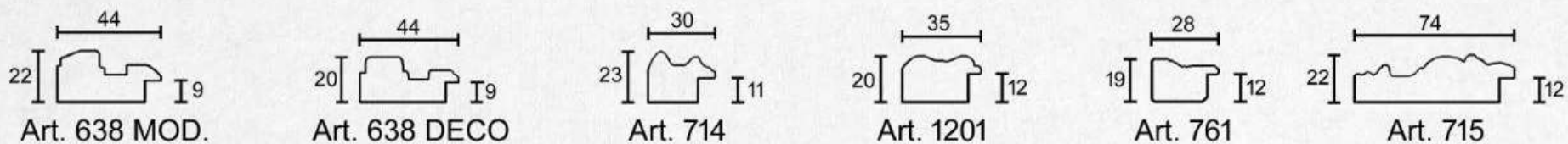

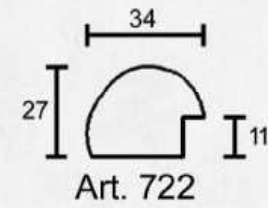
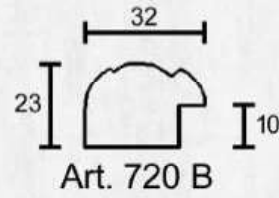
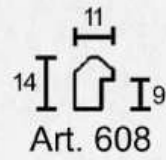
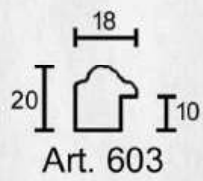
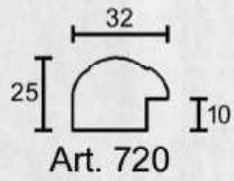
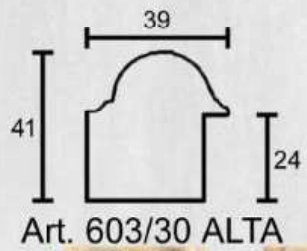

603/30
ALTA

720

603

608

720 B

722

732

738

734

733

603/25

603/20

603/15

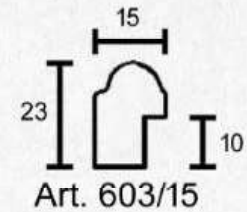
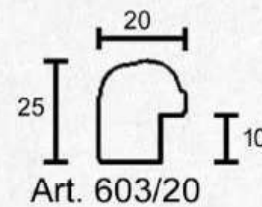
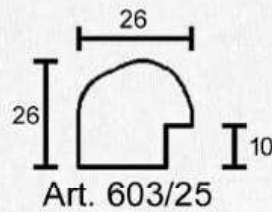
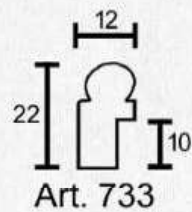
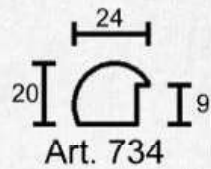
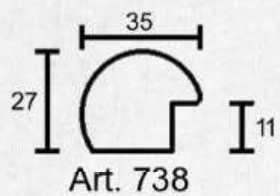

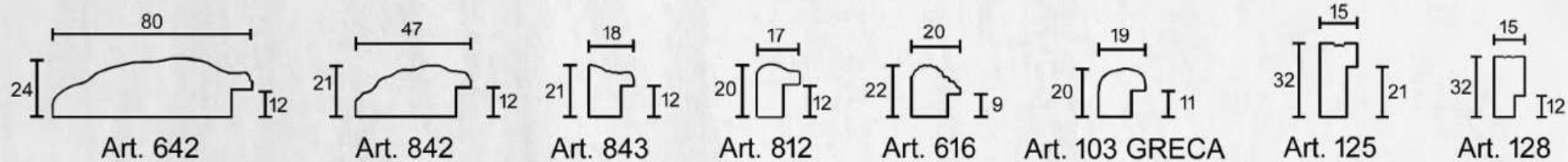

642 842 843 812 616 103 GRECA 125 128 928 689 631 610 652 626 146 TORT. 632 633

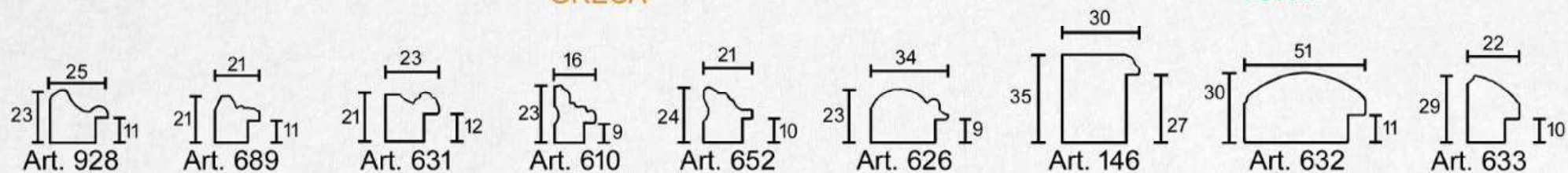

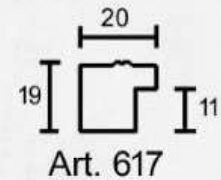
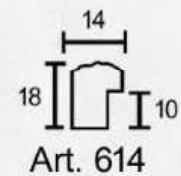
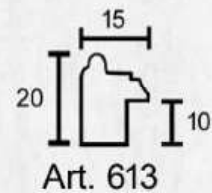
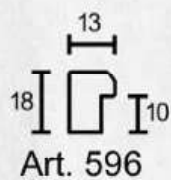
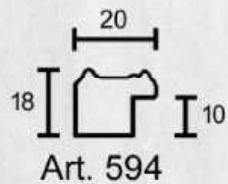
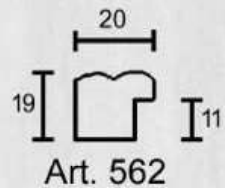

562

594

596

613

614

617

627

649

649

688

735

862

956

SPECIAL

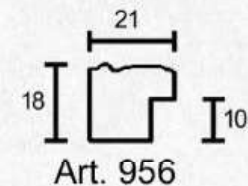
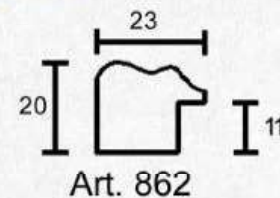
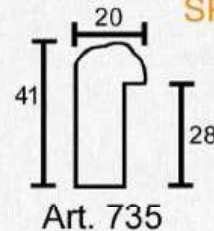
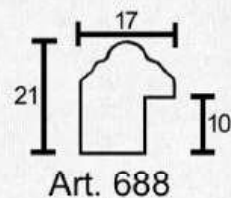
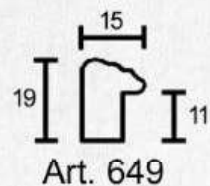
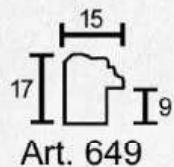
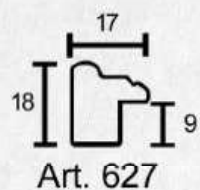

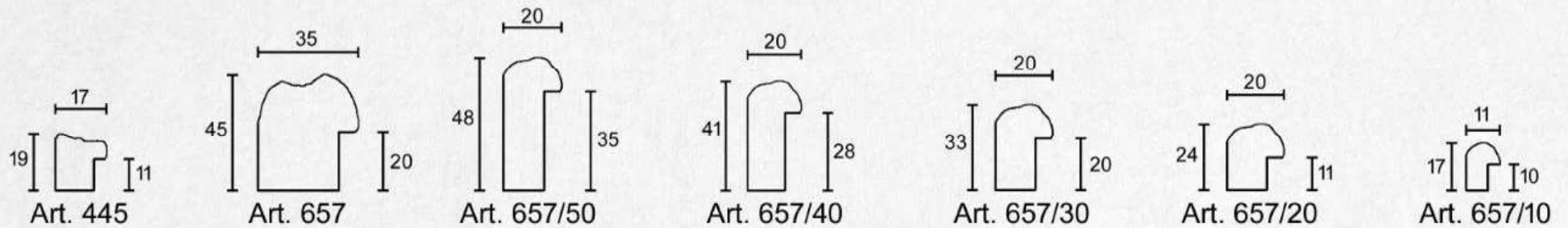
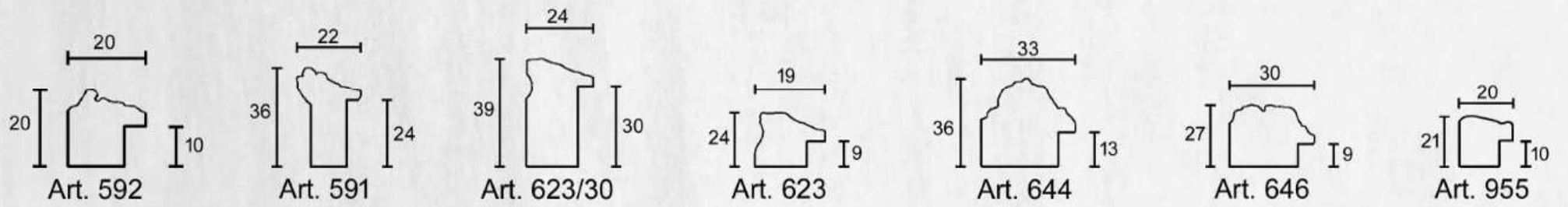

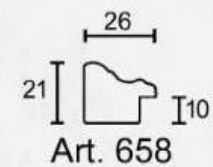
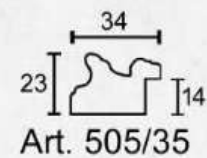
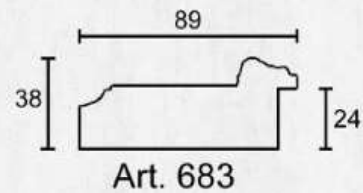
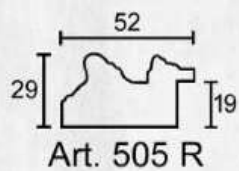
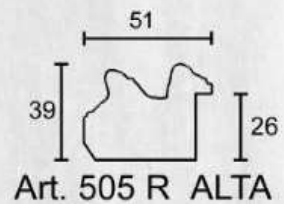
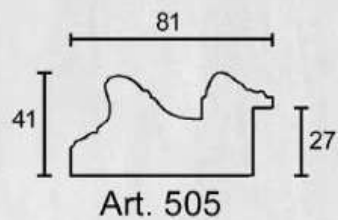

505

505R
ALTA

505 R

683

505/35

658

678

681

673

682

505 R
GUILL. GUILL.

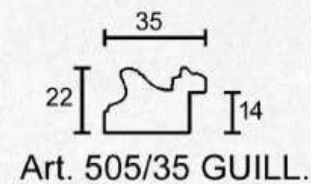
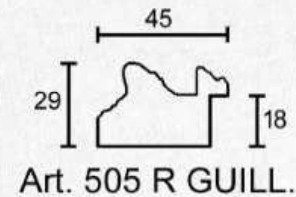
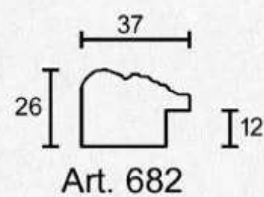
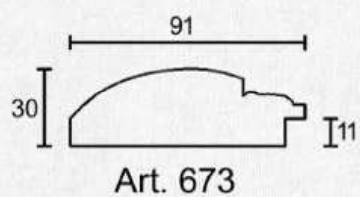
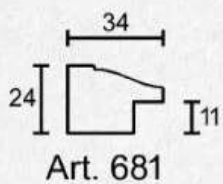
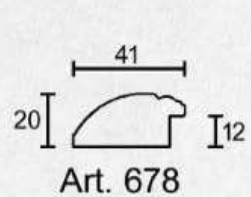

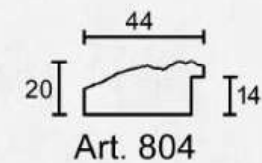
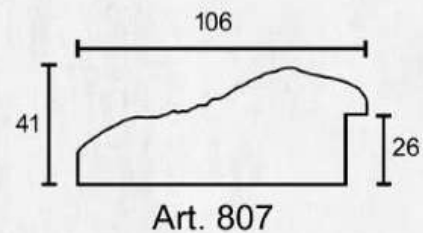
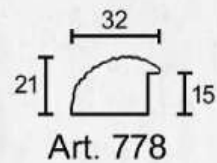
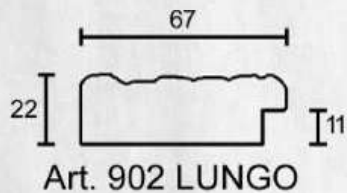
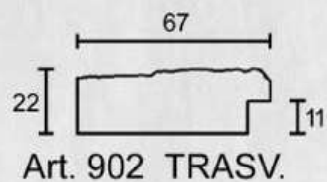

902
TRASV.

902
LUNGO

778

807

804

806

809

809/55

809/35

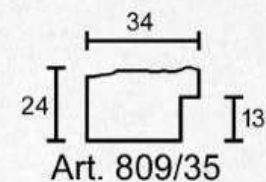
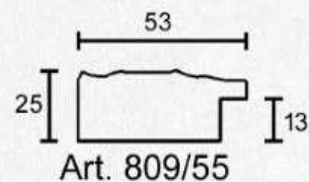
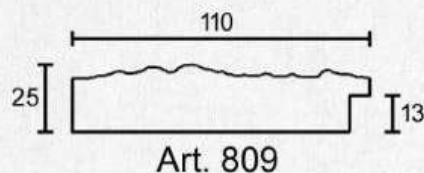
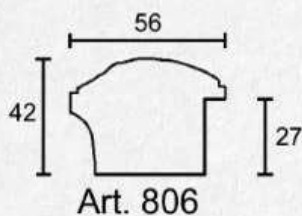

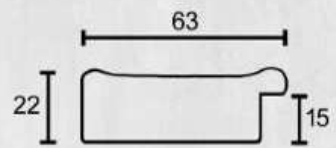

Art. 693

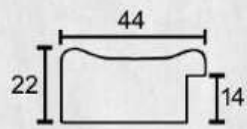

Art. 692

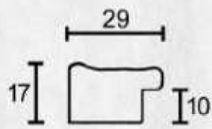

Art. 691

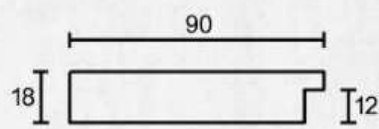

Art. 810/90

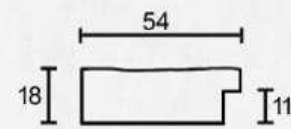

Art. 810

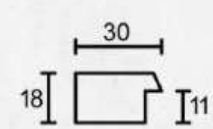

Art. 810/30



693

692

691

810/90

810

810/
30

810/
20

810/
16

900

176

905

904

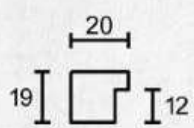

Art. 810/20

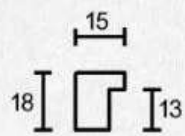

Art. 810/16

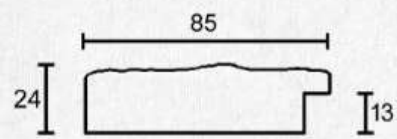

Art. 900

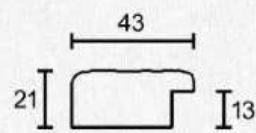

Art. 176

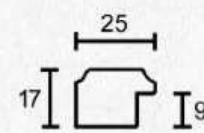

Art. 905

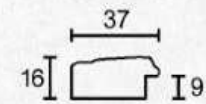

Art. 904

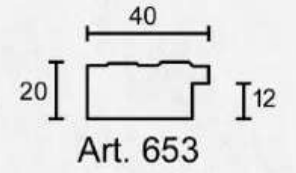
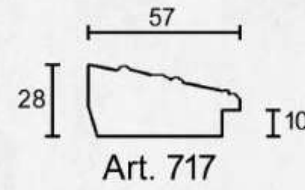
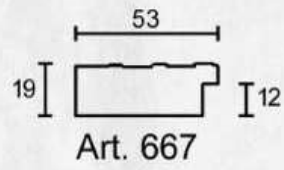
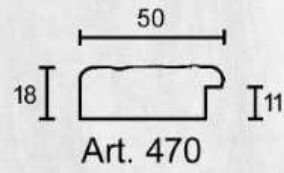
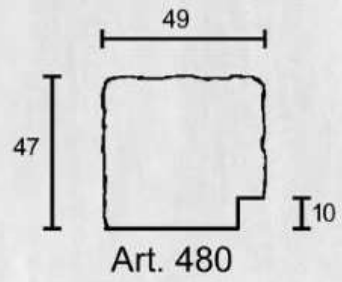

480

470

667

665

717

653

808

925

947

948

995

1221

615

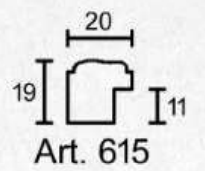
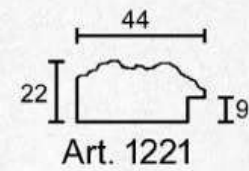
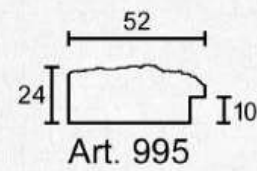
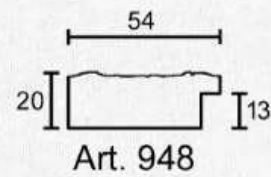
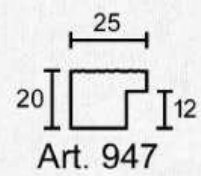
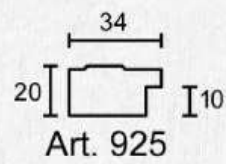
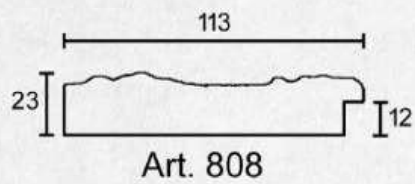

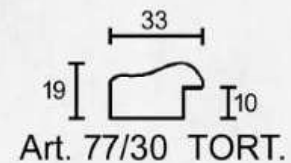
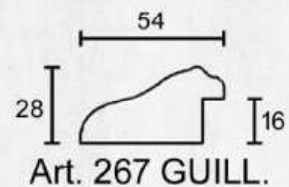
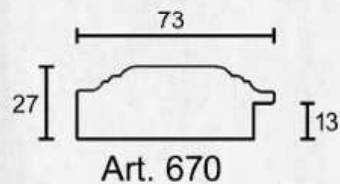
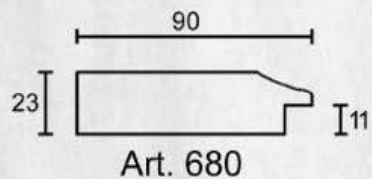
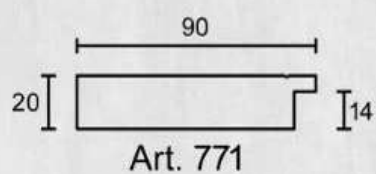

771



680



670



267
GUILL. 77/30
TORT.



1738



PR 45



PR 25



190



160

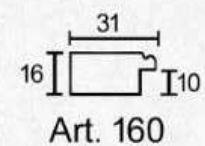
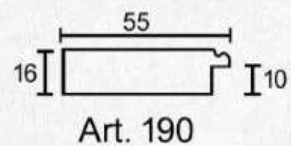
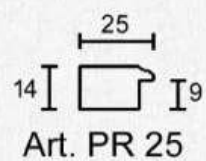
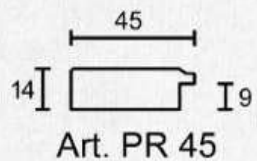
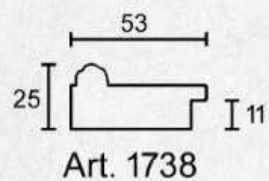

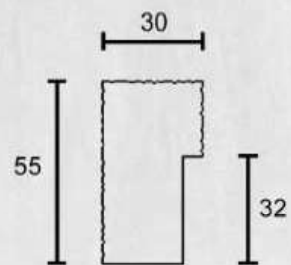

Art. 140/30x55
GRE

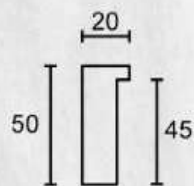

Art. 140/20x50
GRE

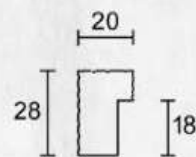

Art. 140/20x28
GRE

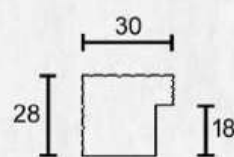

Art. P30x28
GRE

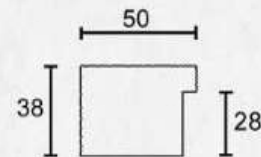

Art. P50x38
GRE

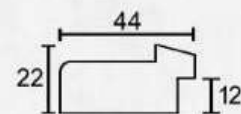

Art. 927 RUS



140/
30x55
GRE

140/
20x50
GRE

140/
20x28
GRE

P30X28
GRE

P50X38
GRE

927
RUS

926
RUS

P20
APR

P20
FLEX

P30
APR

P40
FLEX

83 FLEX

PS 41
APR

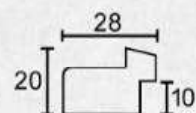

Art. 926
RUS

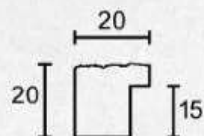

Art. P20
APR

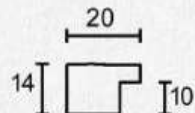

Art. P20
FLEX

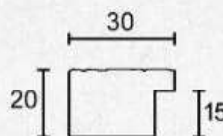

Art. P30
APR

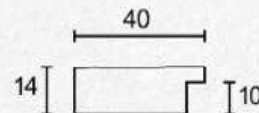

Art. P40
FLEX

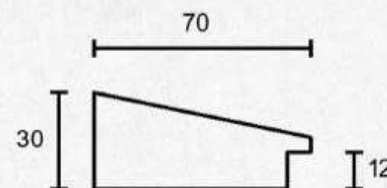

Art. 83
FLEX

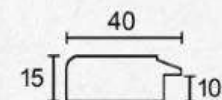

Art. PS 41
APR

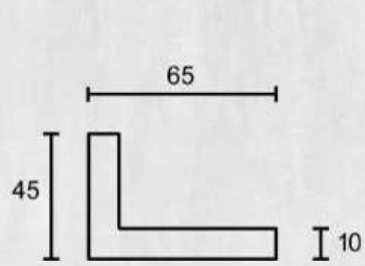

Art. L 45X65

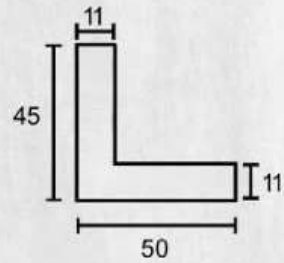

Art. L 45X50

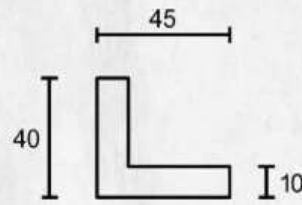

Art. 40X40
ROV

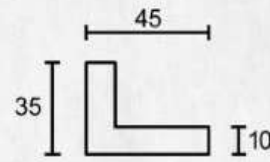

Art. L 35X45

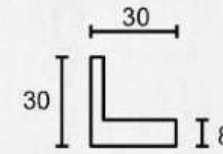

Art. L 30X30
4X8

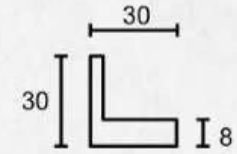

Art. L 30X30
4X8 ROV



L 45X65

L 45X50

L 40X40
ROV

L 35X45

L 30X30
4X8

L 30X30
4X8
ROVERE

725/60
LISCIA

725/60

725

824

251

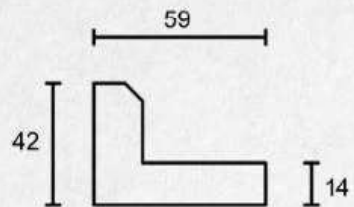

Art. 725/60 LISCIA

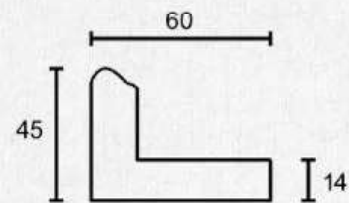

Art. 725/60

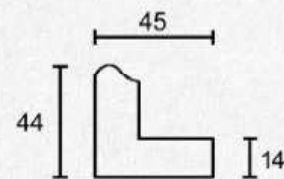

Art. 725

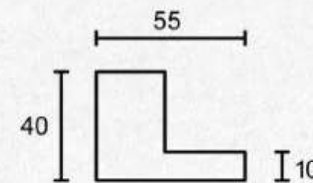

Art. 824

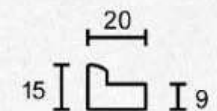

Art. 251

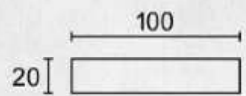

Art.
LISTELLO
100X20

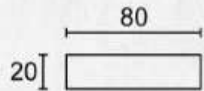

Art.
LISTELLO
80X20

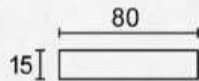

Art.
LISTELLO
80X15

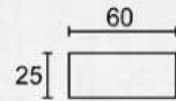

Art.
LISTELLO
60X25

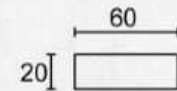

Art.
LISTELLO
60X20

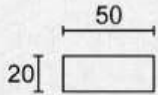

Art.
LISTELLO
50X20

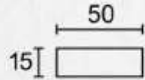

Art.
LISTELLO
50X15

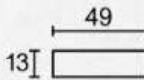

Art.
LISTELLO
50X12

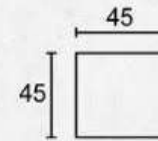

Art.
LISTELLO
45X45



LIST.
100X20

LIST.
80X20

LIST.
80X15

LIST.
60X25

LIST.
60X20

LIST.
50X20

LIST.
50X15

LIST.
50X12

LIST.
45X45

LIST.
30X15

LIST.
20X10

LIST.
18X15

LIST.
15X10

LIST.
10X10

RIAL.
45

RIAL.
25

TELAIO
DS 50

AYOUS

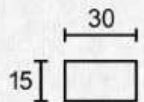

Art.
LISTELLO
30X15

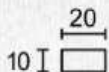

Art.
LISTELLO
20X10

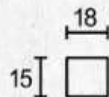

Art. LISTELLO
18X15
AYOUS

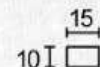

Art.
LISTELLO
15X10

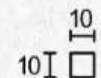

Art.
LISTELLO
10X10

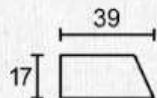

Art. RIALZO 45

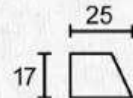

Art. RIALZO 25

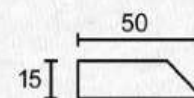

Art. TELAIO DS 50

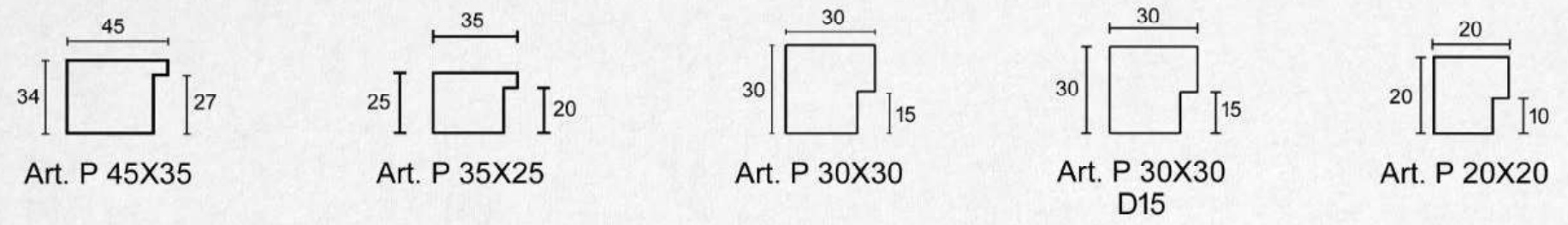
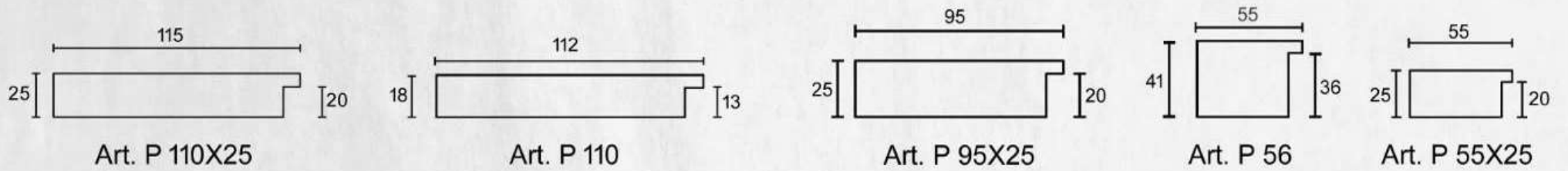

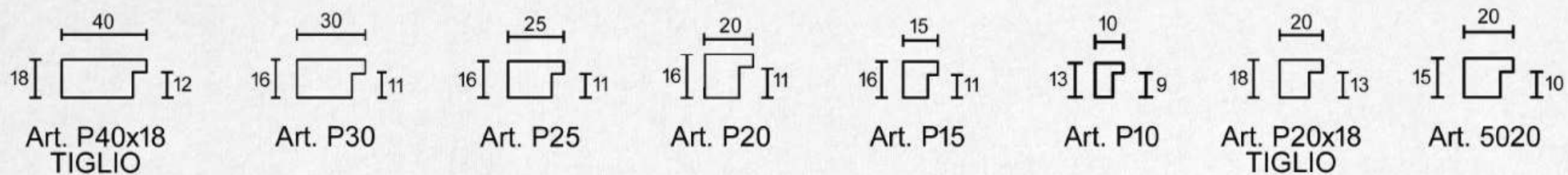
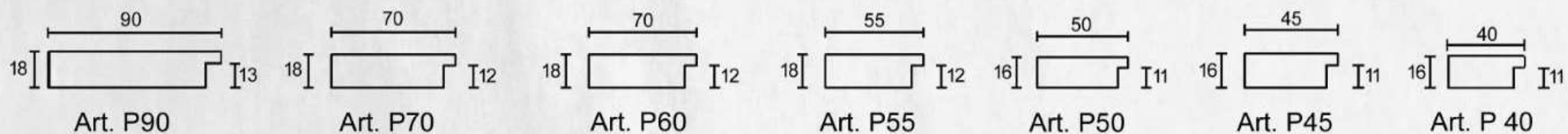

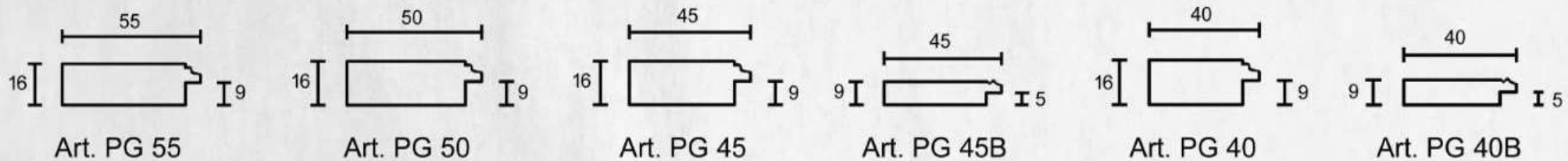

PG 55 PG 50 PG 45 PG 45B PG 40 PG 40B PG 35B PG 30 PG 30B PG 25B PG20 PG 15 PG 10

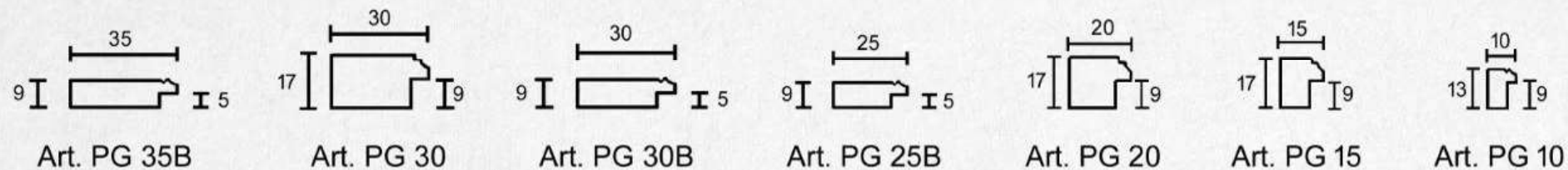

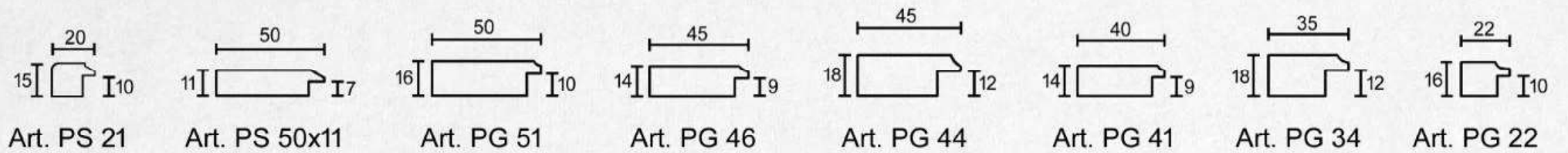
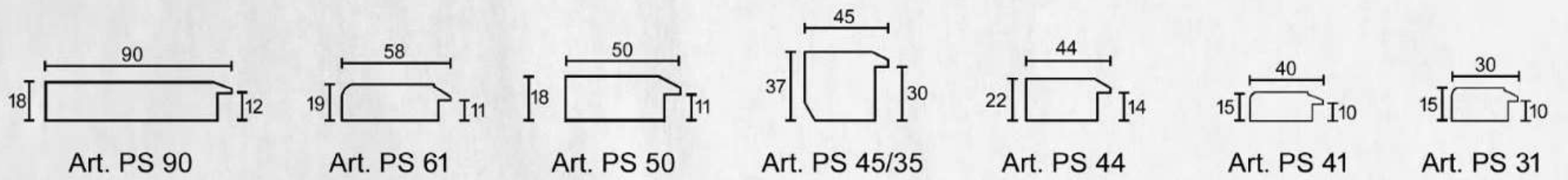

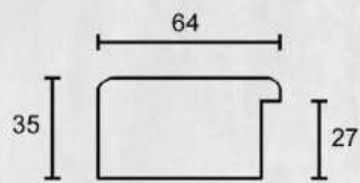

Art. P64x35

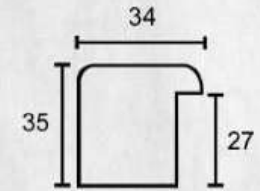

Art. P34x35

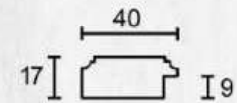

Art. PG2/40

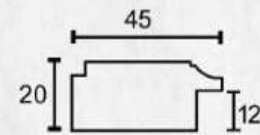

Art. 413

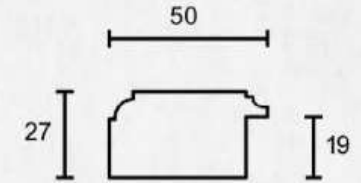

Art. 154/50 ALTA



P64x35

P34x35

PG2/40

413

154/50
ALTA

154/50

154/40

154

113

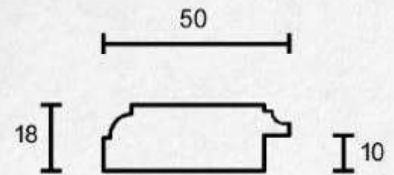

Art. 154/50

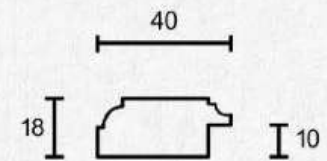

Art. 154/40

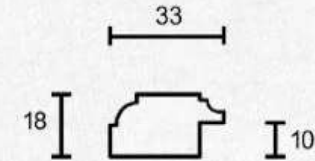

Art. 154

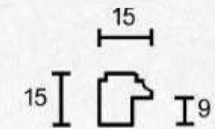

Art. 113

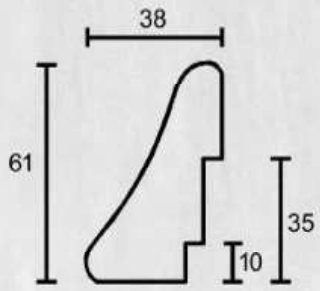

Art. 938

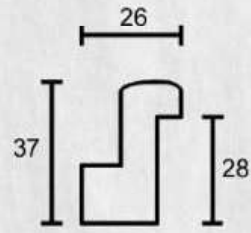

Art. 909 BASE

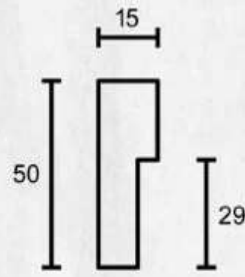

Art. 115

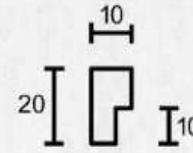

Art. 116

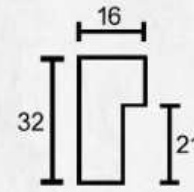

Art. 123

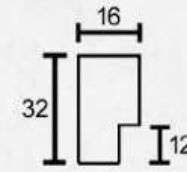

Art. 124

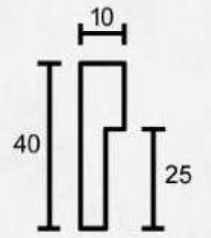

Art. 140/10x40



938

909
BASE

115

116

123

124

140/
10x40

140/
35x80

142

146

195

894

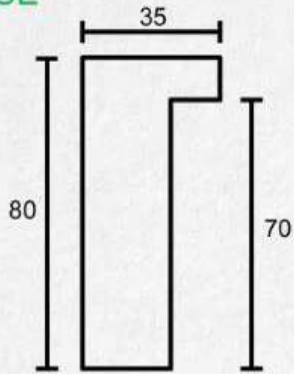

Art. 140/35x80

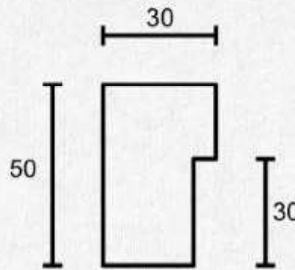

Art. 142

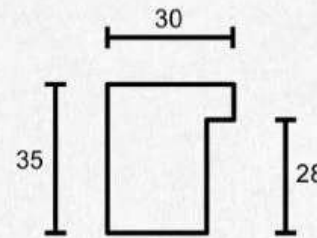

Art. 146

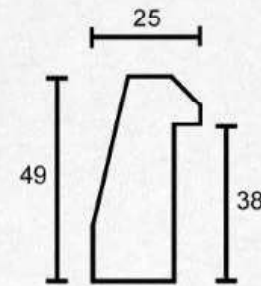

Art. 195

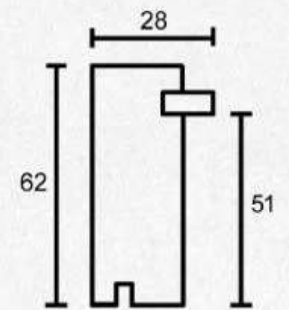

Art. 894

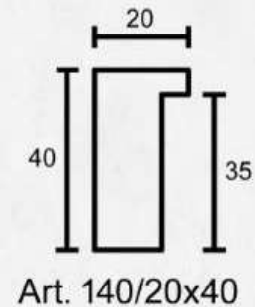
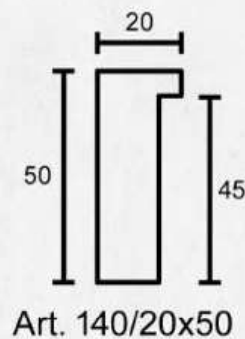
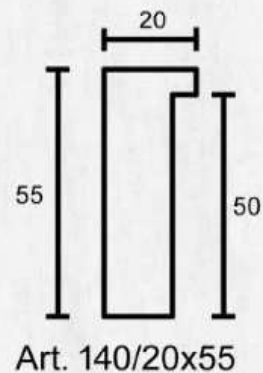
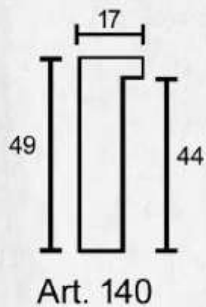
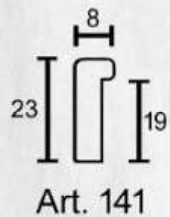
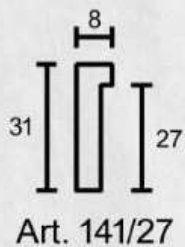
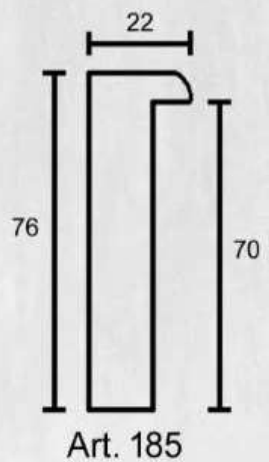

185 141/27 141 140 140/20x55 140/20x50 140/20x40 140/30 140/25x35 140/13x34 140/8x35 140/7x22 121

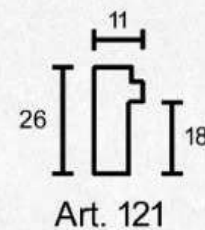
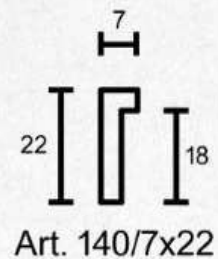
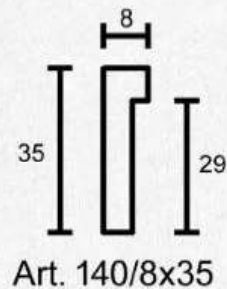
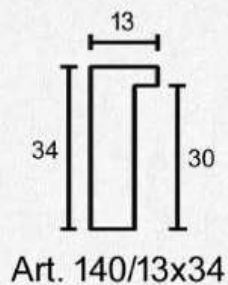
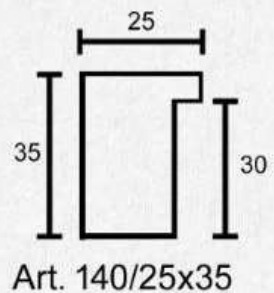
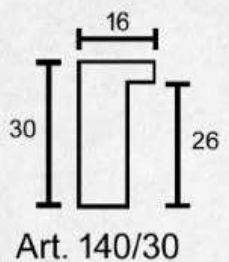

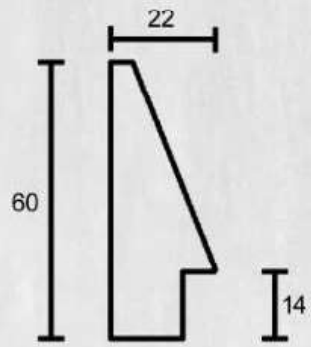

Art. 131/60x25

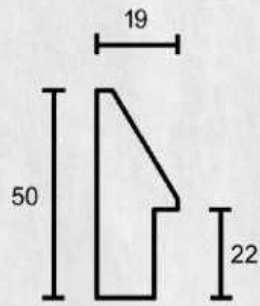

Art. 131/51

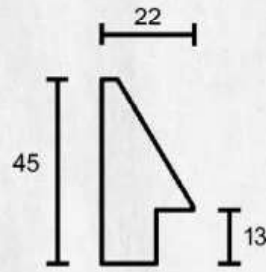

Art. 131/66

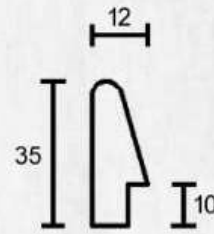

Art. 131/36

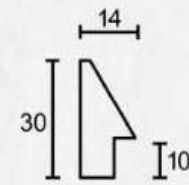

Art. 131/30

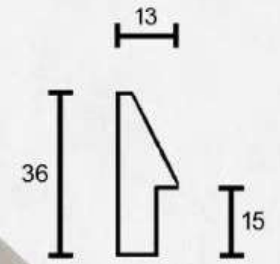

Art. 131/15

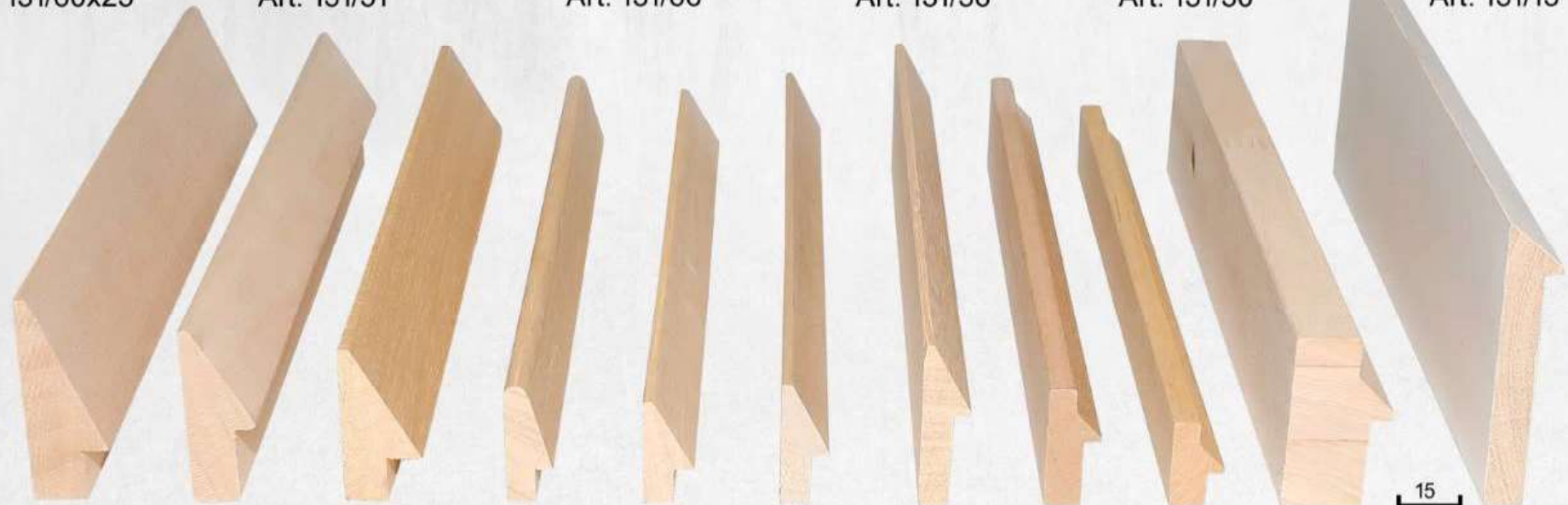

131/
60x25

131/51

131/66

131/36

131/30

131/15

131

167/20

167

164

184

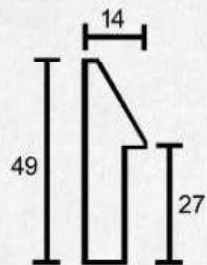

Art. 131

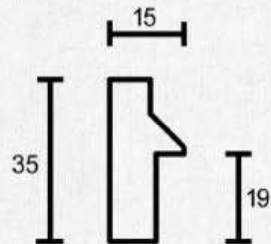

Art. 167/20

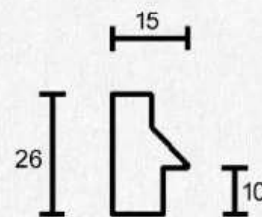

Art. 167

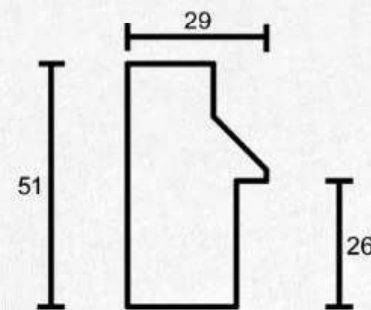

Art. 164

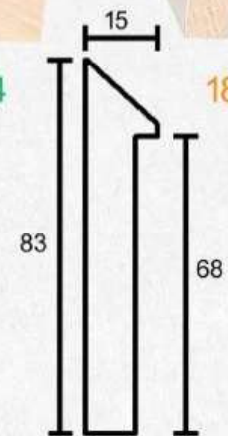

Art. 184

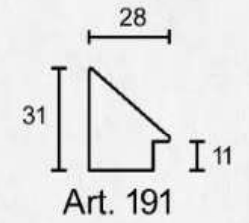
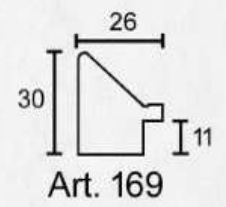
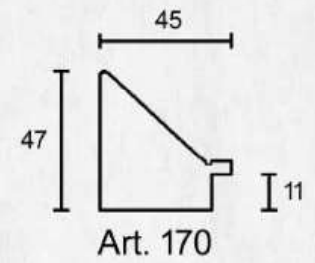
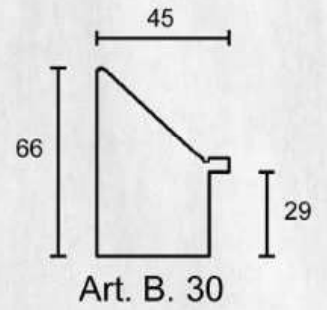
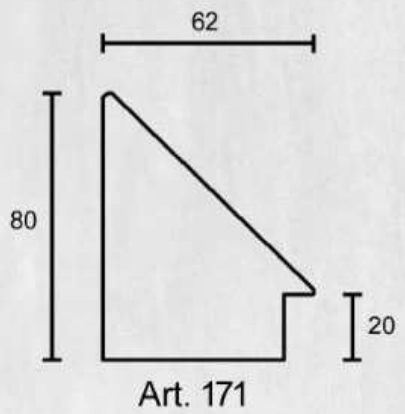

171

170 B.30

170

169

191

183

83

79N
BATT. 27

79N

78

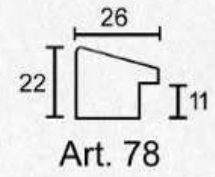
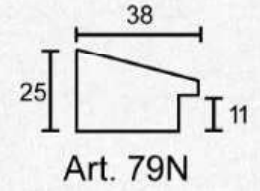
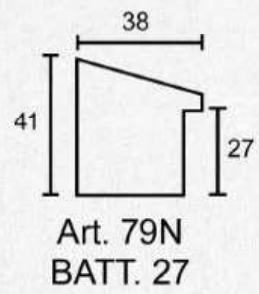
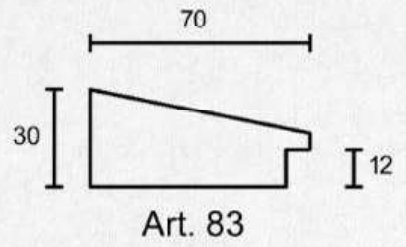
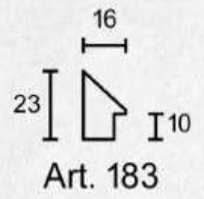

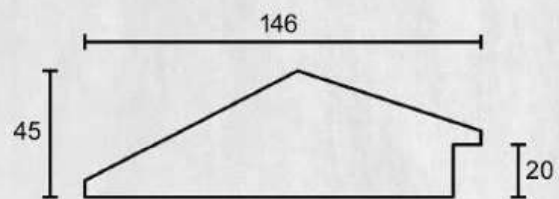

Art. 1164

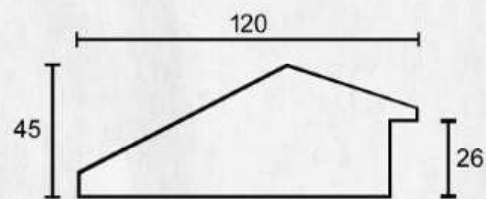

Art. 1163

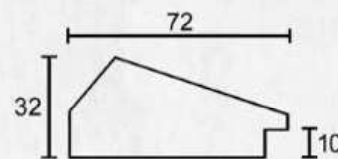

Art. 973

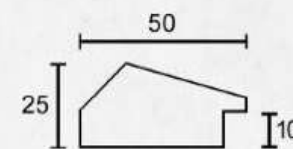

Art. 972



1164

1163

973

972

971

SOLE 5

168

174

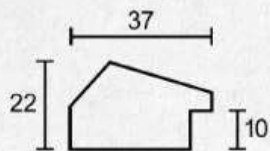

Art. 971

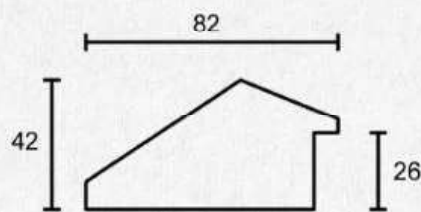

Art. SOLE 5

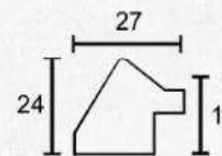

Art. 168

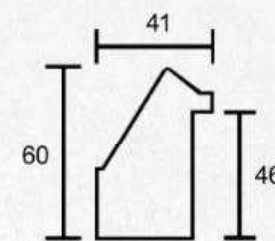

Art. 174

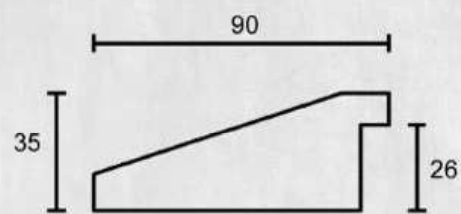

Art. 276/80

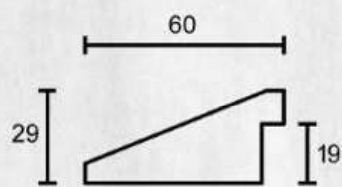

Art. 276/60

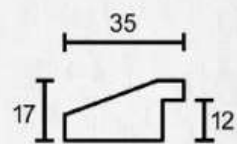

Art. 276/35

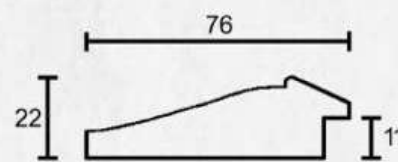

Art. 277

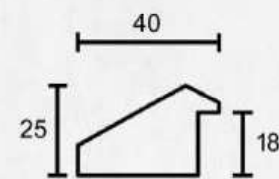

Art. 1166



276/80

276/60

276/35

277

1166

1167

192

108

131/60x27

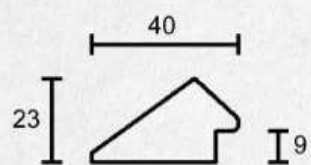

Art. 1167

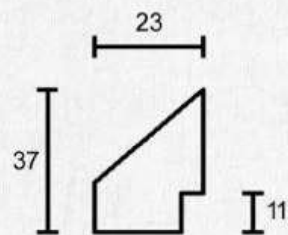

Art. 192

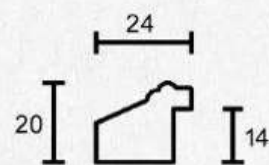

Art. 108

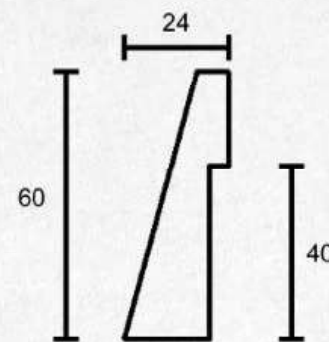

Art. 131/60x27

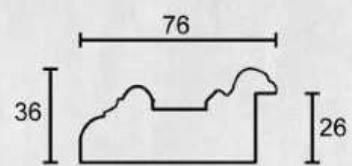

Art. 149

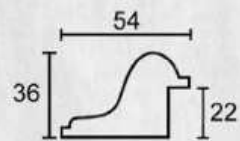

Art. 224/55

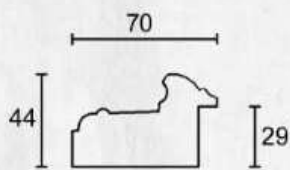

Art. 225

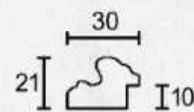

Art. 328

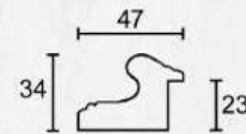

Art. 330

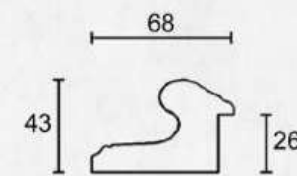

Art. 331



149

224/55

225

328

330

331

401

402

2052

2053

3002

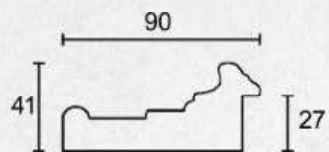

Art. 401

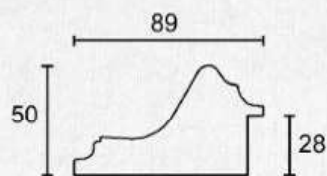

Art. 402

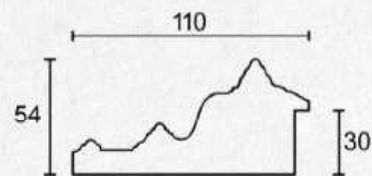

Art. 2052

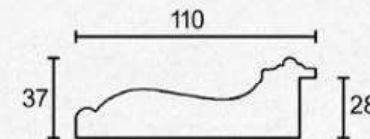

Art. 2053

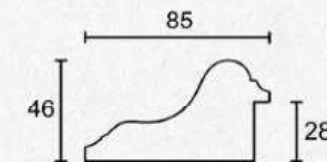

Art. 3002

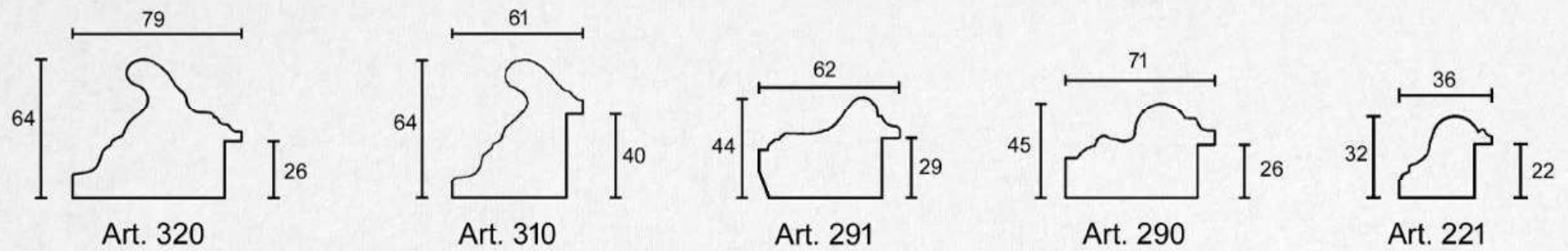
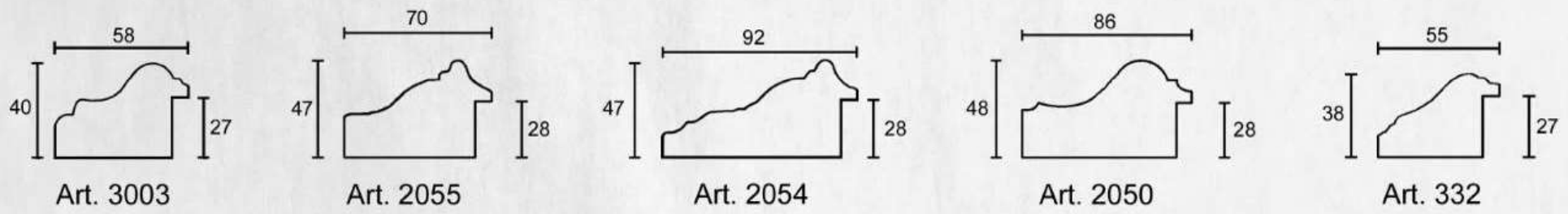

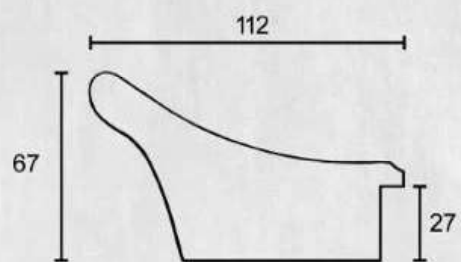

Art. 403

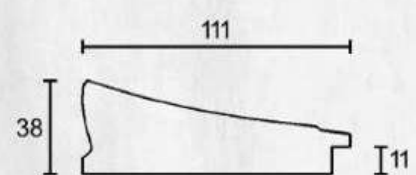

Art. 410

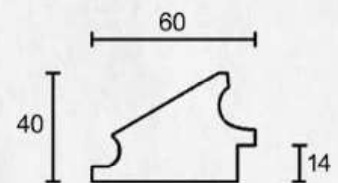

Art. 922

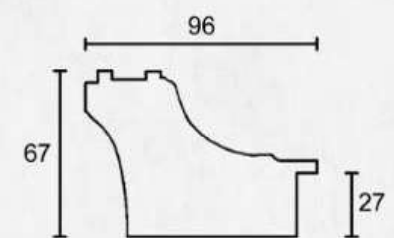

Art. 1601



403

410

922

1601

483
ALTA

483

484

355

100/60

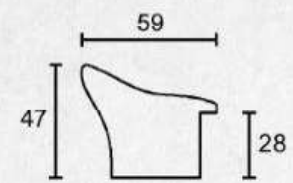

Art. 483 ALTA

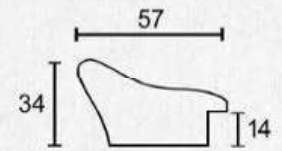

Art. 483

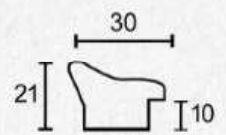

Art. 484

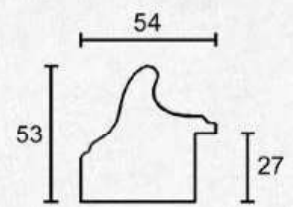

Art. 355

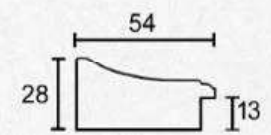

Art. 100/60

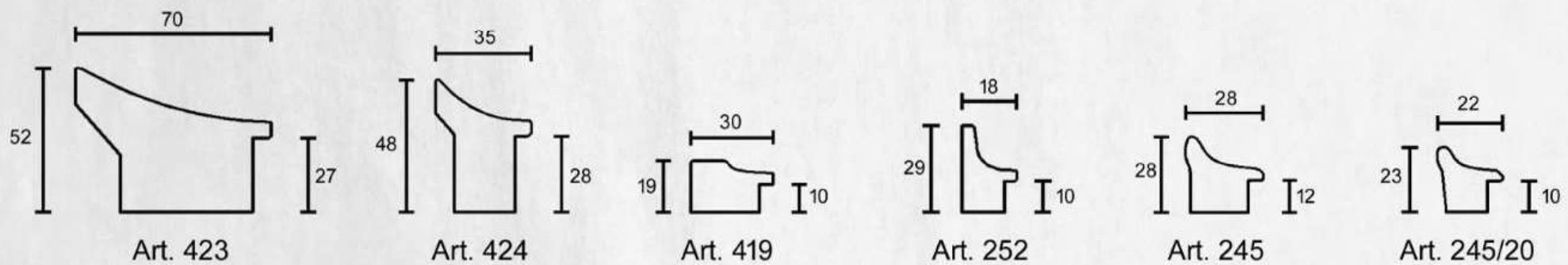

423 424 419 252 245 245/20 120 111/30 111 100/40 524 912

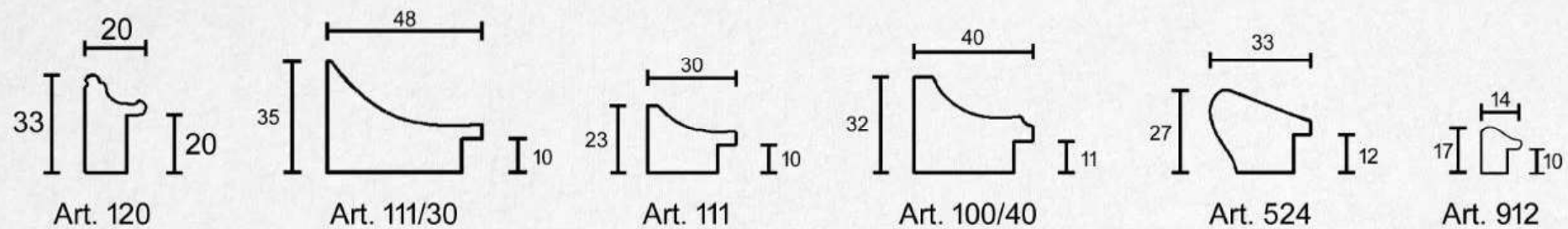

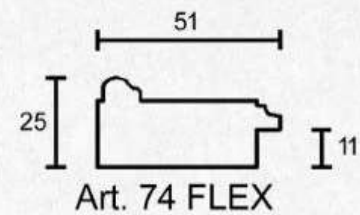
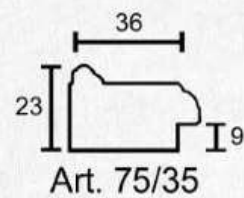
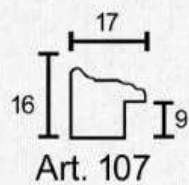
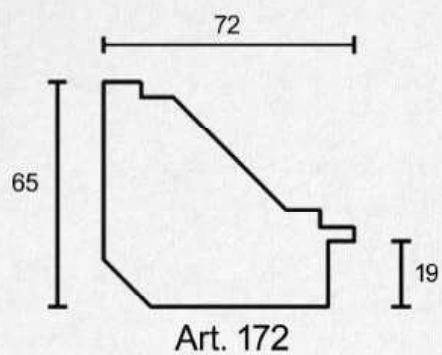
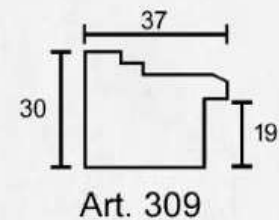
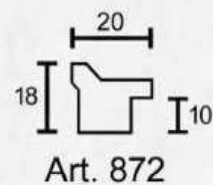
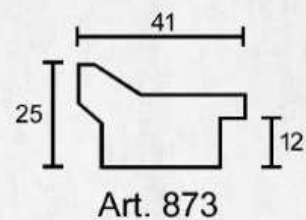
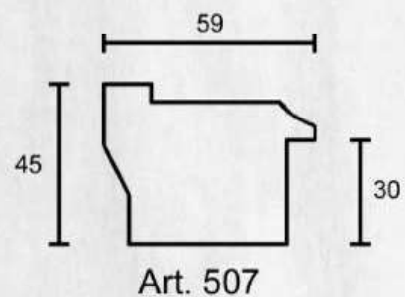
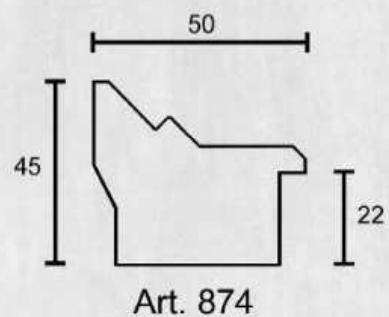

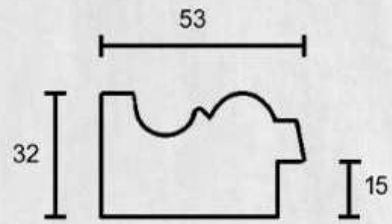

Art. 860

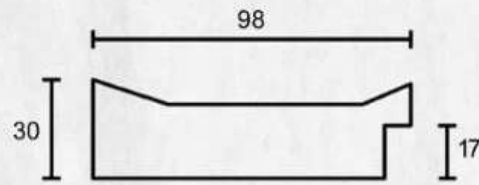

Art. 750

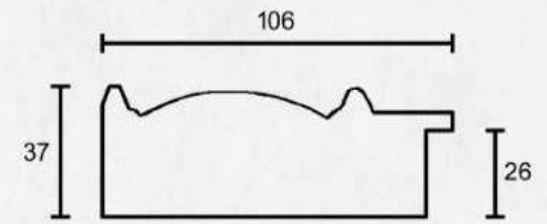

Art. 695 LISCIA



860

750

695 LISCIA

450

390

379

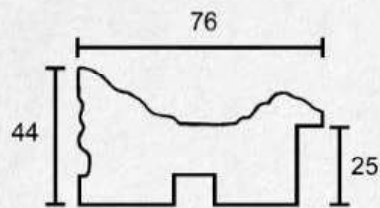

Art. 450

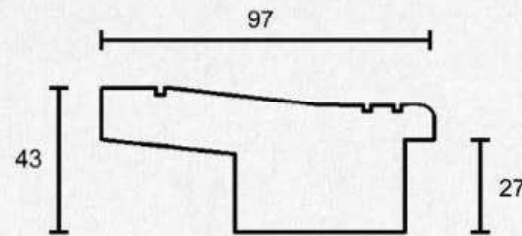

Art. 390

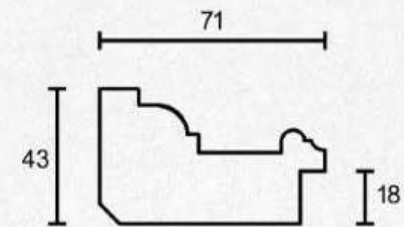

Art. 379

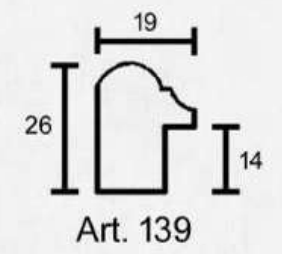
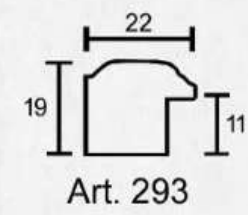
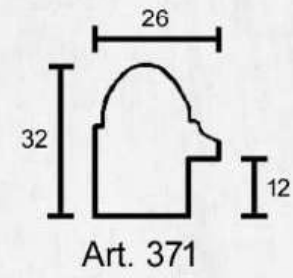
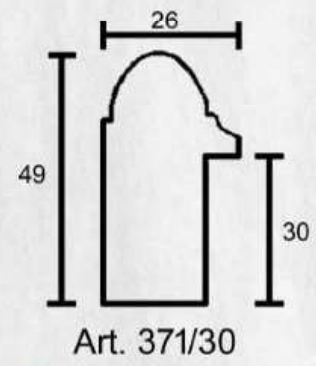
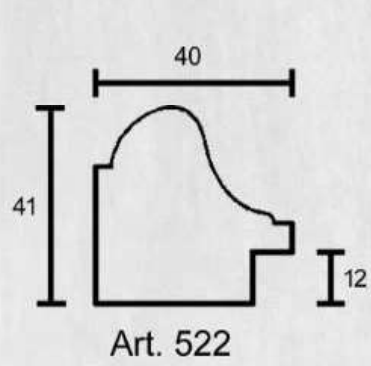

522 371/30 371 293 139 P 36 P 26 P 16 P16 GOYA 202 202 N

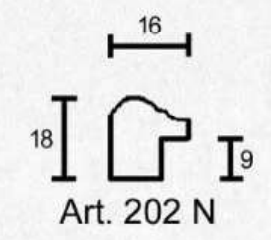
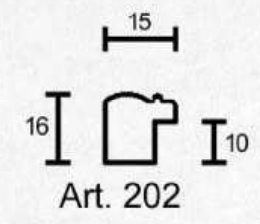
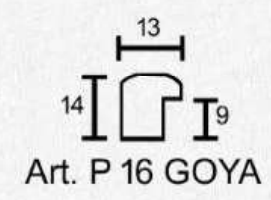
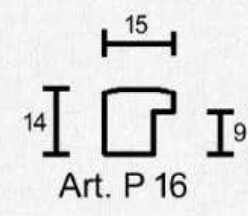
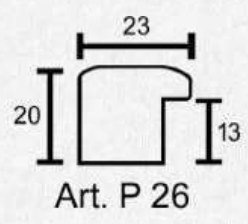
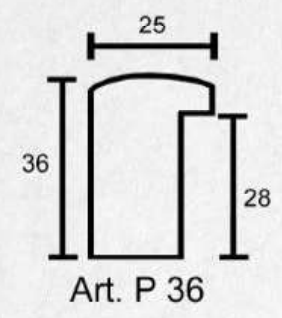

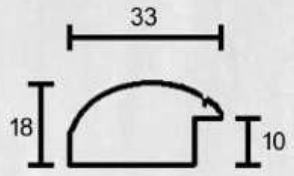

Art. 275

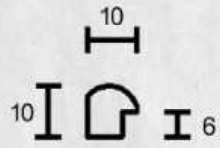

Art. 233

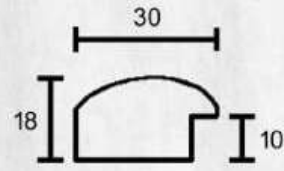

Art. 114

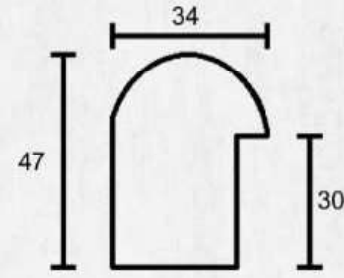

Art. 104 T ALTA

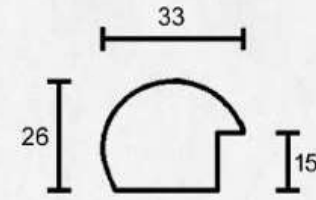

Art. 104

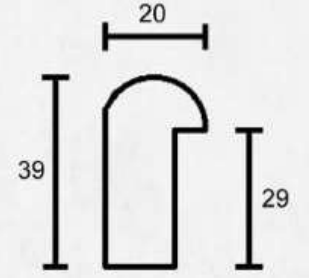

Art. 103/30



275

233

114

104 T ALTA

104

103/30

103 A

103

102/20

102 T

102

101/30

101 GOYA

101

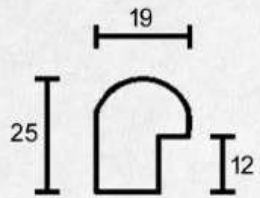

Art. 103 A

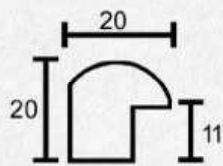

Art. 103

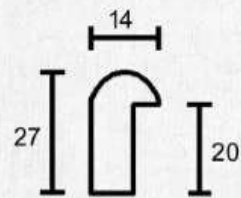

Art. 102/20

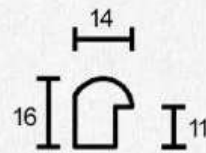

Art. 102 T

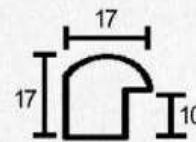

Art. 102

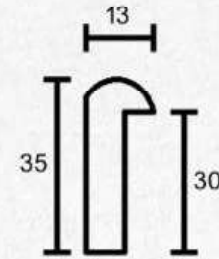

Art. 101/30

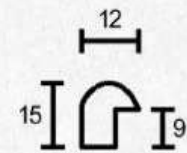

Art. 101 GOYA

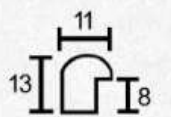

Art. 101

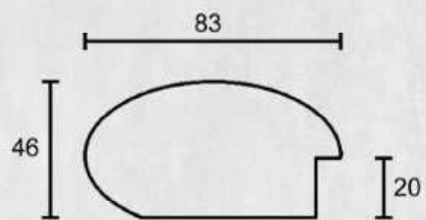

Art. 1014

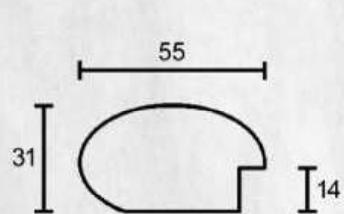

Art. 1013

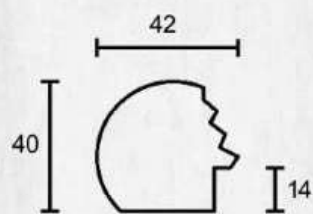

Art. 944

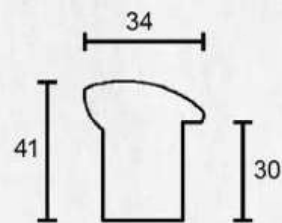

Art. 514/30

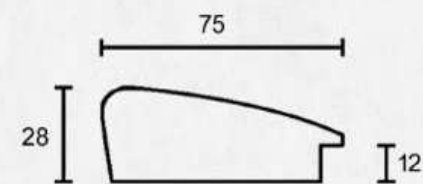

Art. 490



1014

1013

944

514/30

490

491

273

105

105G

531

514

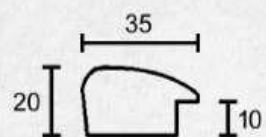

Art. 491

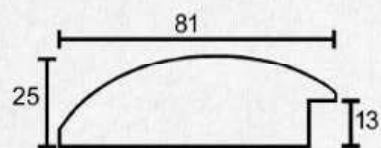

Art. 273

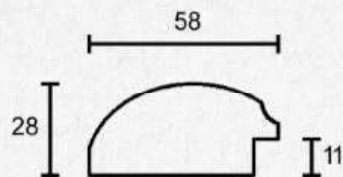

Art. 105

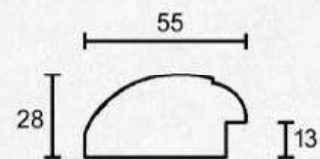

Art. 105G

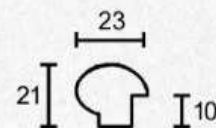

Art. 531

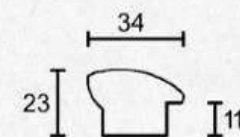

Art. 514

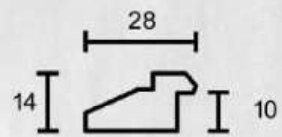

Art. 996

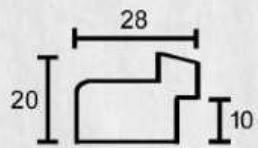

Art. 926

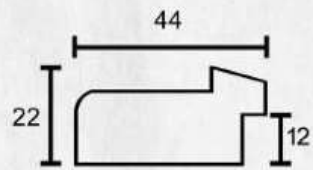

Art. 927

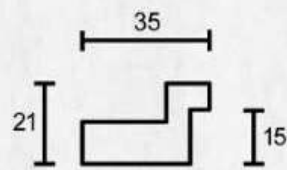

Art. 515

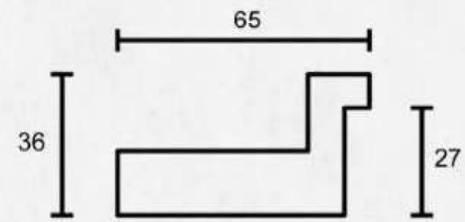

Art. 415

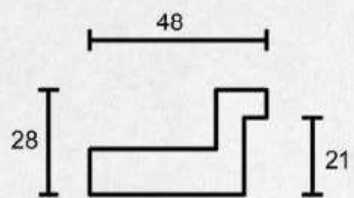

Art. 415/48

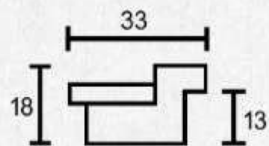

Art. 41515

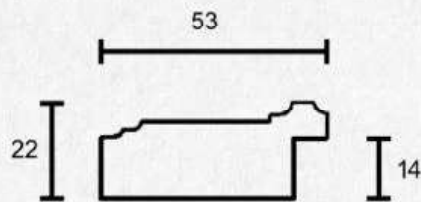

Art. 244

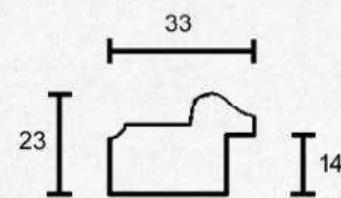

Art. 201 B

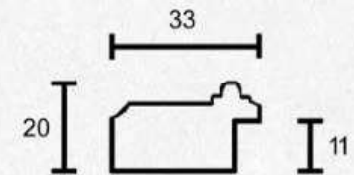

Art. 201

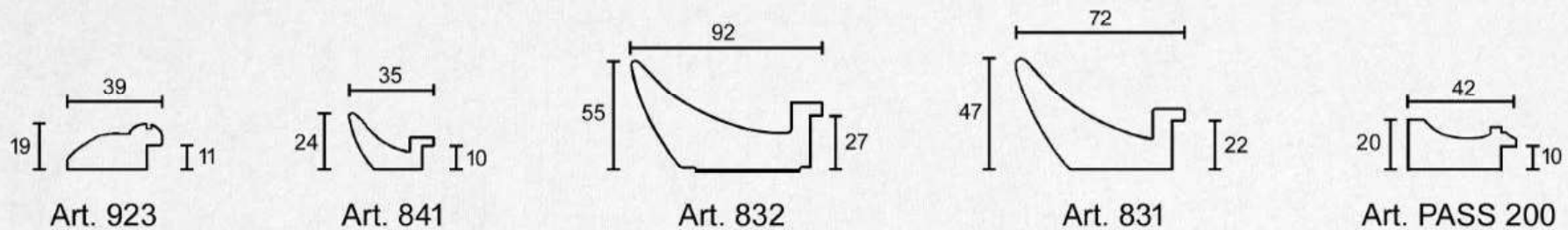
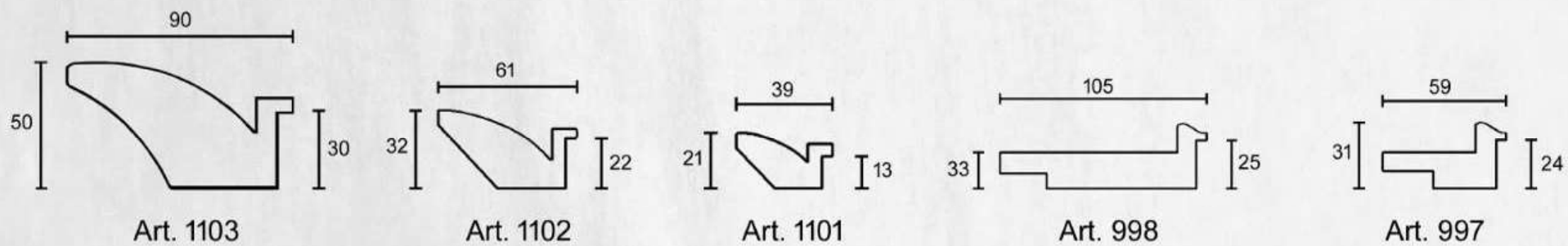

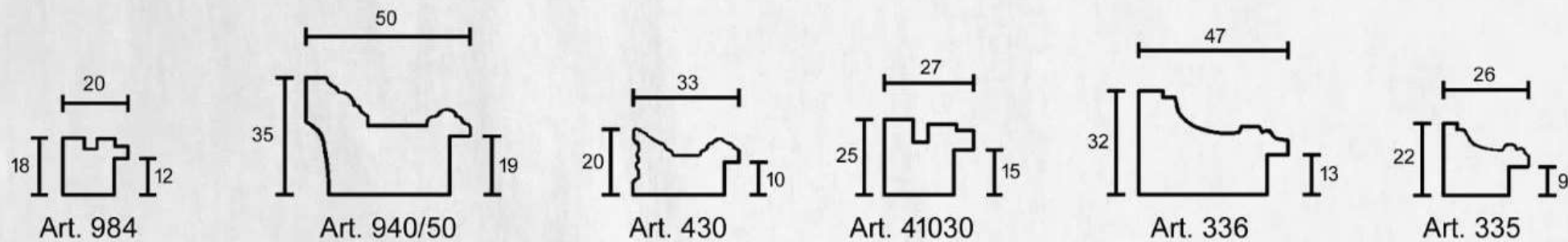

984 940/50 430 41030 336 335 271 240 205 204 162 70 67 241

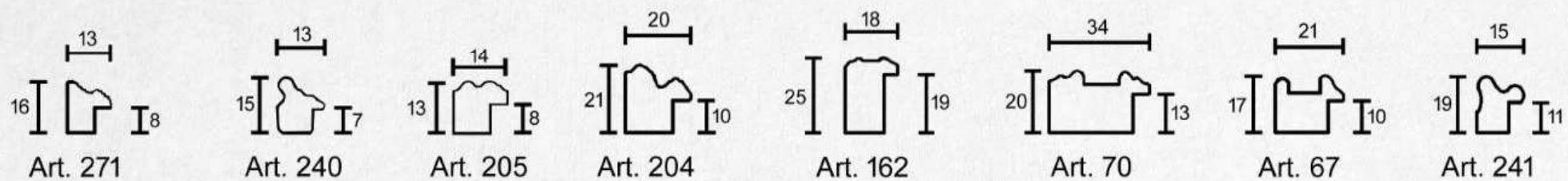

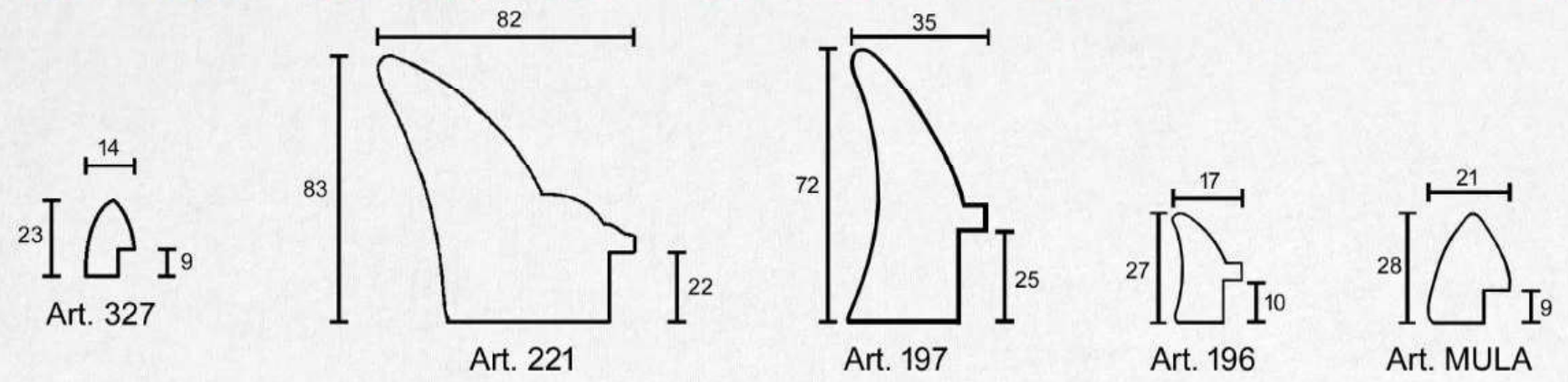
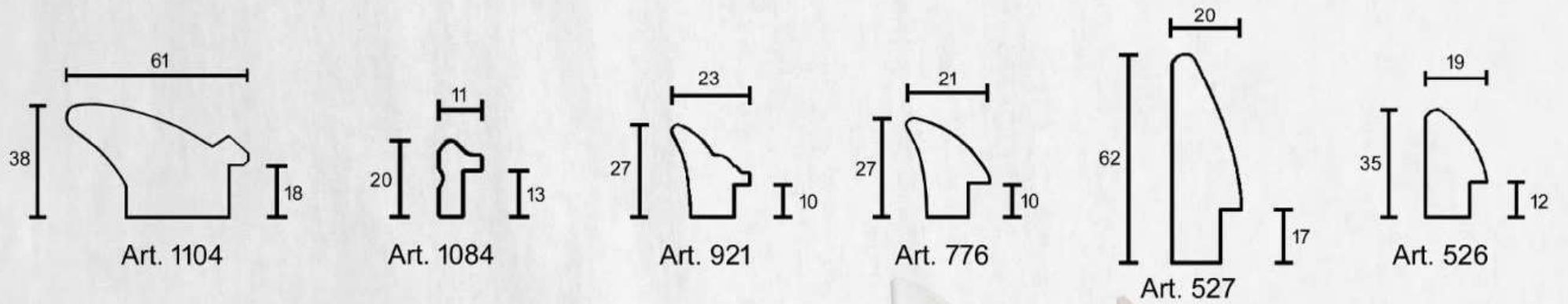

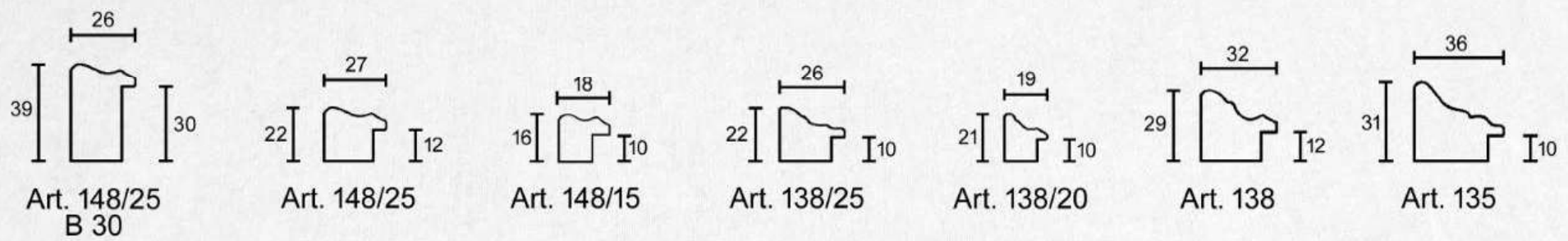
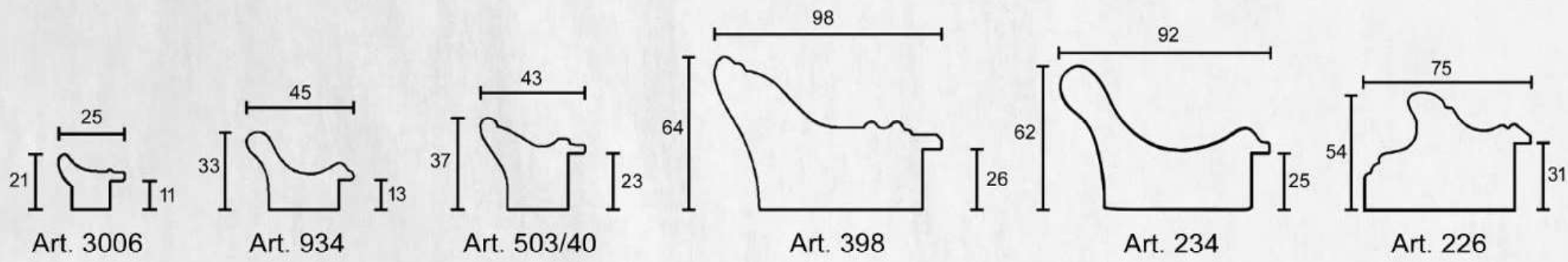

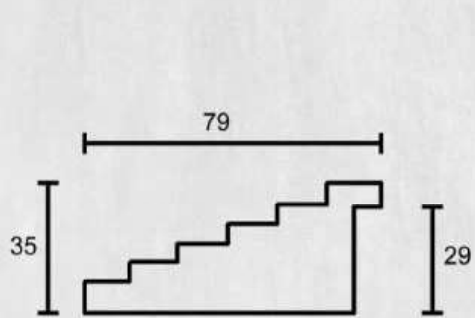

Art. 3001

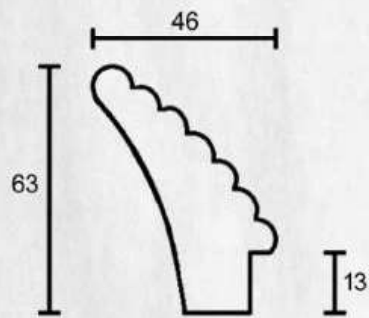

Art. 787

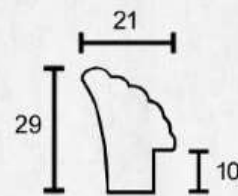

Art. 777

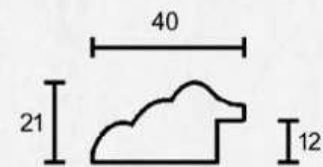

Art. 521

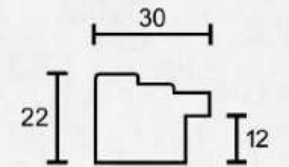

Art. 308

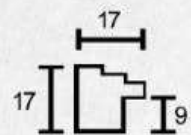

Art. 307

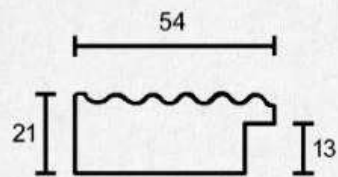

Art. 288/55

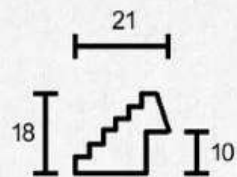

Art. 283

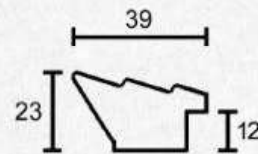

Art. 282

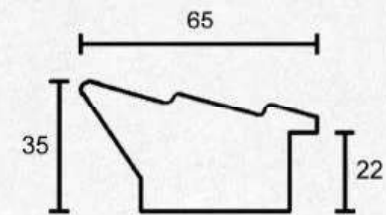

Art. 281

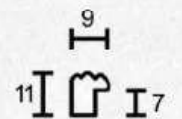

Art. 246

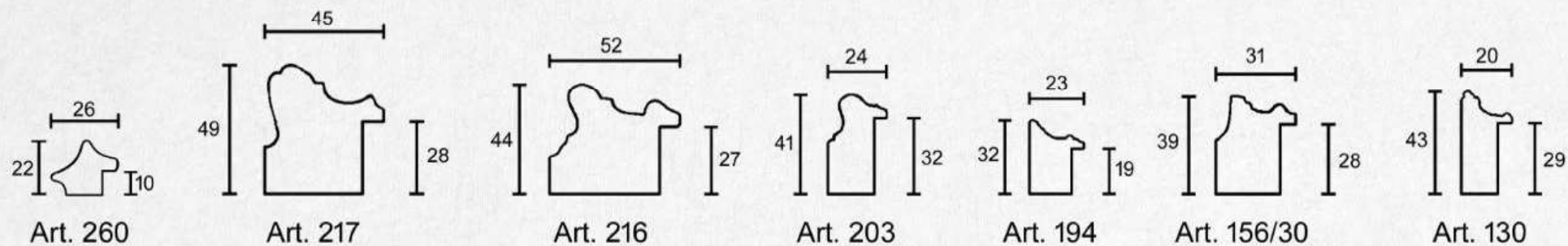
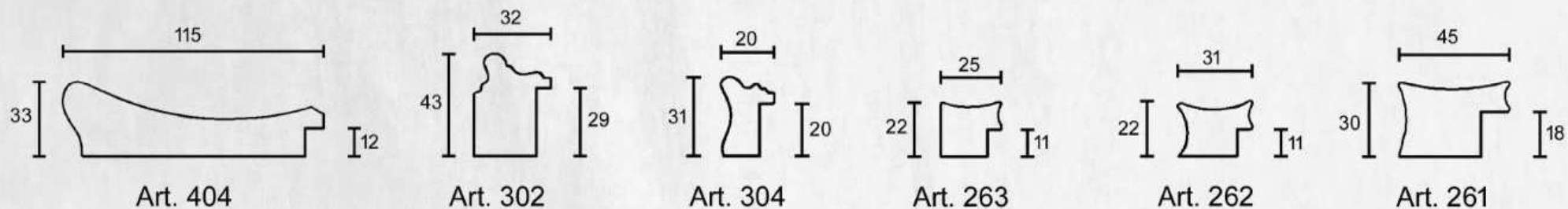

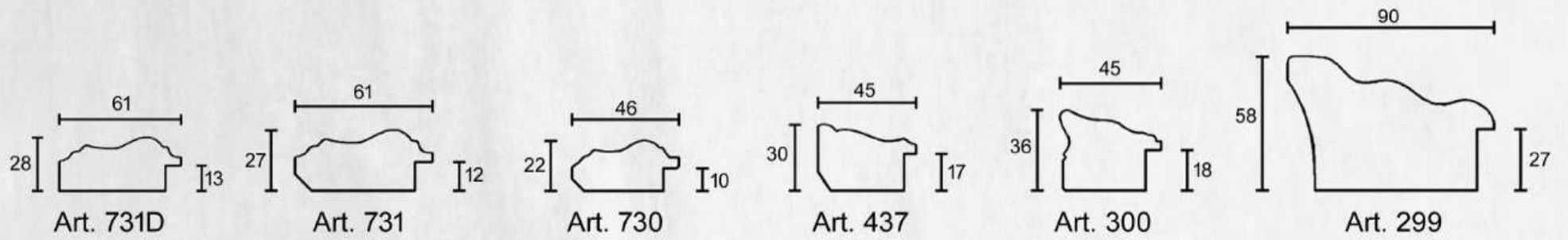

731D 731 730 437 300 299 223 137 ALTA 137 136/30 136

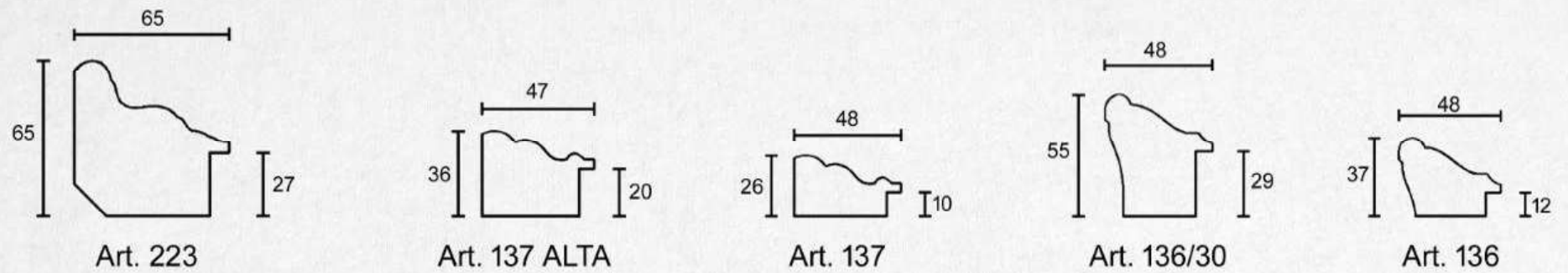

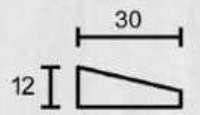

Art. DS 30

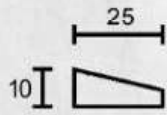

Art. DS 25

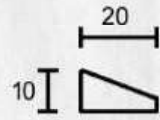

Art. DS 20

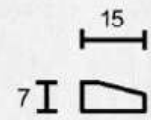

Art. DS 15

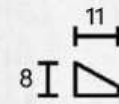

Art. DS 10

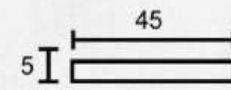

Art. D45

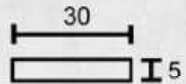

Art. D30

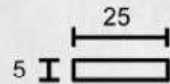

Art. D25

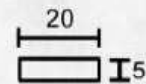

Art. D 20

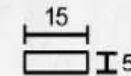

Art. D 15

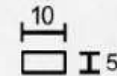

Art. D 10

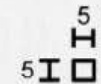

Art. D 05



DS 30 DS 25 DS 20 DS 15 DS 10 D 45 D 30 D 25 D 20 D 15 D 10 D 05 DG 45 DG 30 DG 20 DG 20B DG 15 PIP PIP G

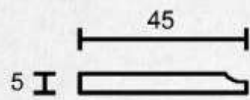

Art. DG 45

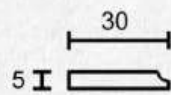

Art. DG 30

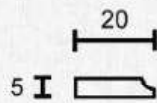

Art. DG 20

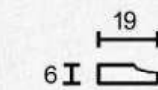

Art. DG 20B

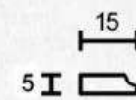

Art. DG 15

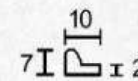

Art. PIP

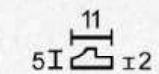

Art. PIP G

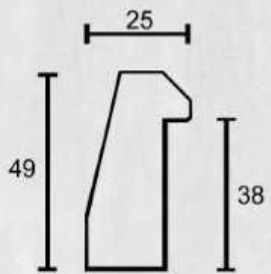

Art. 195
ROVERE

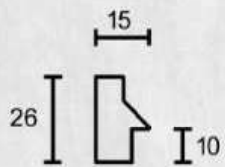

Art. 167
ROVERE

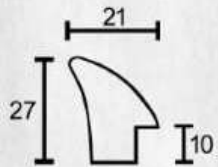

Art. 776
ROVERE

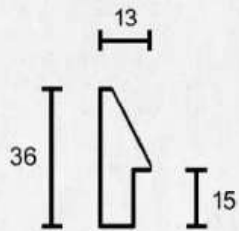

Art. 131/15
NOCE

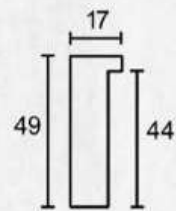

Art. 140
ROVERE

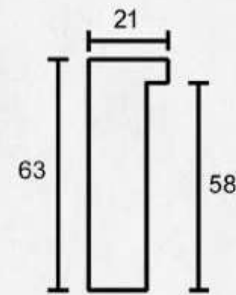

Art. 140/20x63
CILIEGIO

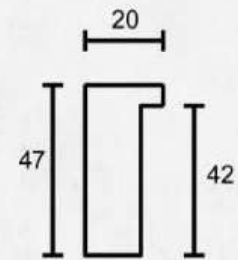

Art. 140/20x47
TULIPIER



195
ROV.

167
ROV.

776
ROV.

131/15
NOCE

140
ROV.

140/
20X63
CIL.

140/
20X47
TULIPIER

140/
15X47
D 10
TULIPIER

140/30
FAGGIO

140/30
CIL.

140/30
ROV.

140/
13x35
ROV.

140/
13x25
ROV.

116
CILIEGIO

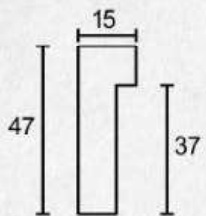

Art. 140/15x47
D 10 TULIPIER

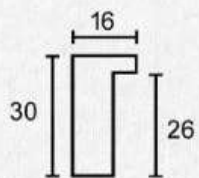

Art. 140/30
FAGGIO

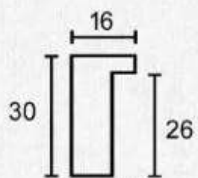

Art. 140/30
CILIEGIO

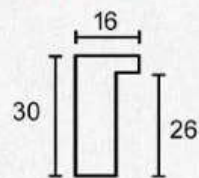

Art. 140/30
ROVERE

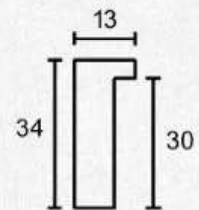

Art. 140/13x35
ROVERE

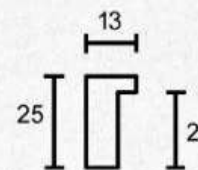

Art. 140/13x25
ROVERE

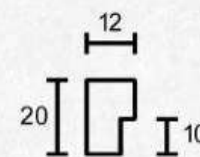

Art. 116
CILIEGIO

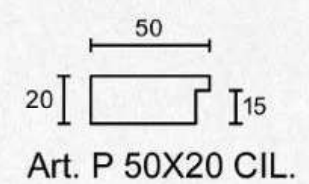
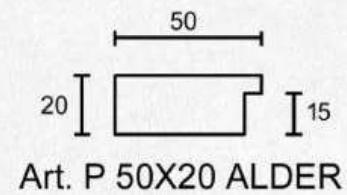
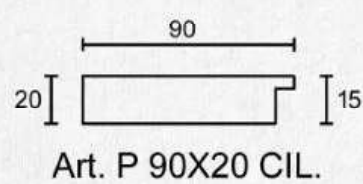
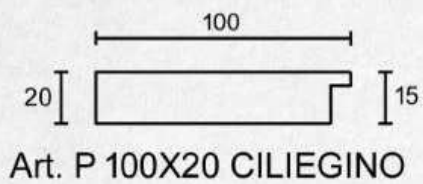
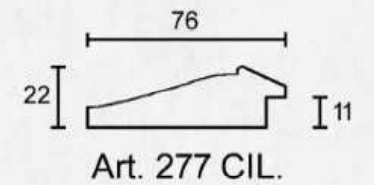
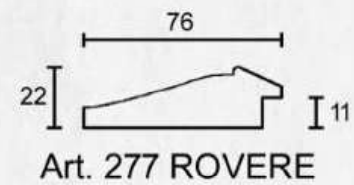
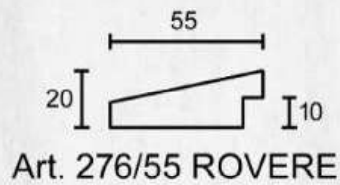
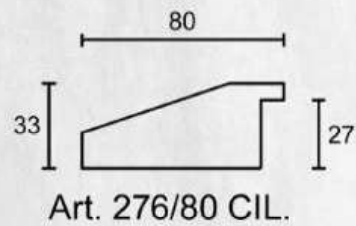
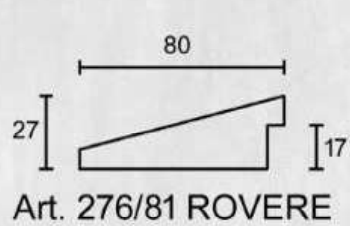

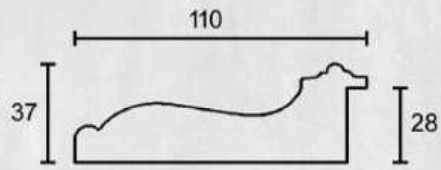

Art. 2053 CIL.

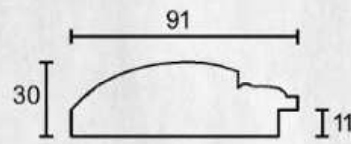

Art. 673 CIL.

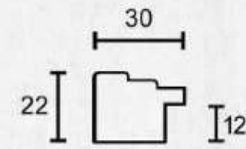

Art. 308 ROVERE

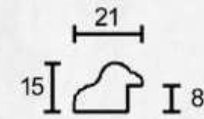

Art. 296 CIL.

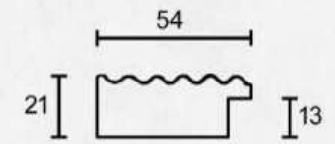

Art. 288/55 CIL.



2053 CIL.

673 CIL.

308
ROV.

296
CIL.

288/55
CIL.

288 CIL.

273 CIL.

77/60
CIL.

77/30
CIL.

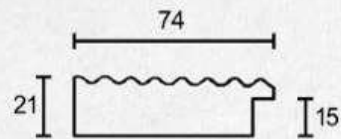

Art. 288 CIL.

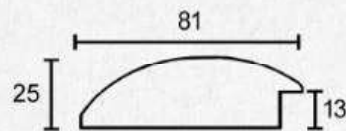

Art. 273 CIL.

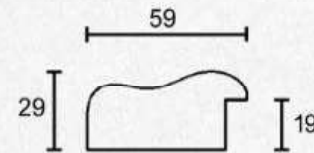

Art. 77/60 CIL.

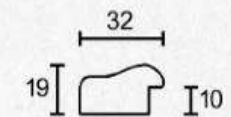

Art. 77/30 CIL.

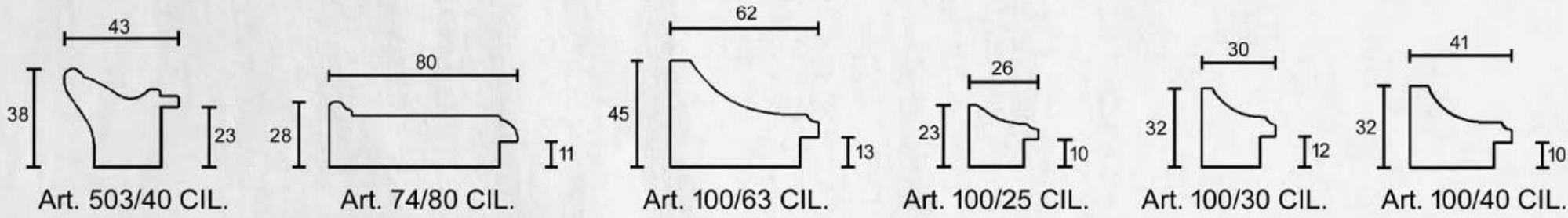

503/40 CIL. 74/80 CIL. 100/63 CIL. 100/25 CIL. 100/30 CIL. 100/40 CIL. 252 ROV. 872 ROV. 872 CIL. 873 ROVERE 873 CILIEGIO 1072 CILIEGIO BIANCO OLD 1073

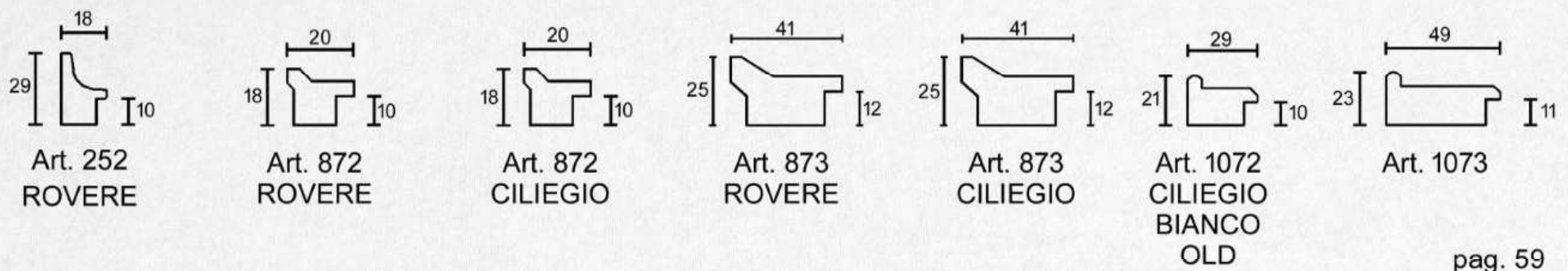

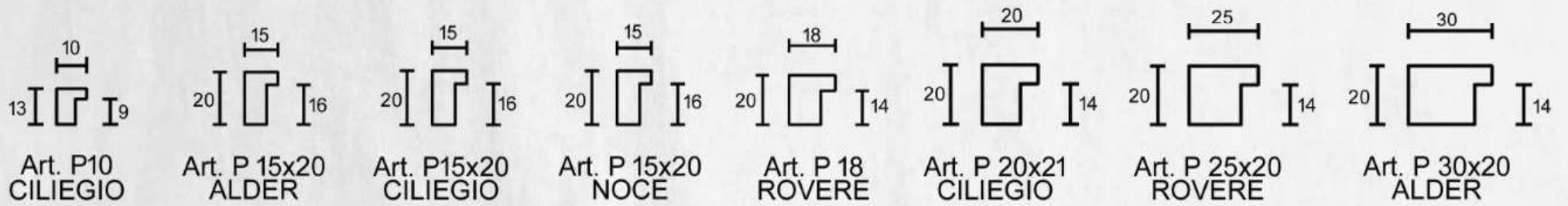

P10 CIL. P15x20 ALDER P15x20 CIL. P15x20 NOCE P18 ROV. P20x21 CIL. P25x20 ROVERE P30x20 ALDER P30x20 ROVERE P30x20 NOCE P40x20 ROVERE P40x20 CILIEGIO P40x20 NOCE P30x20 CILIEGIO

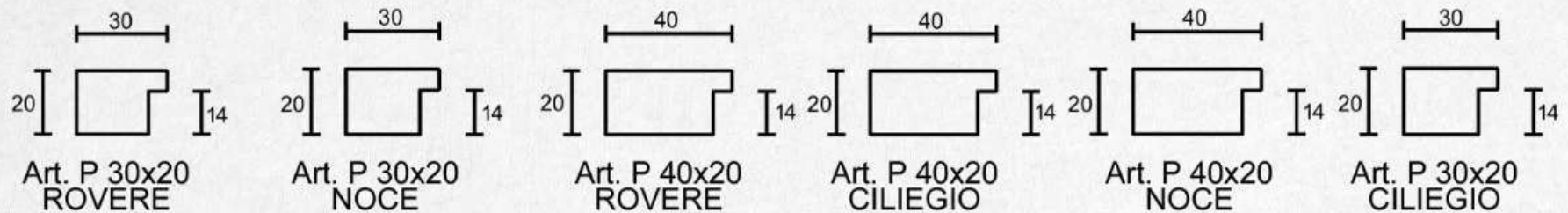

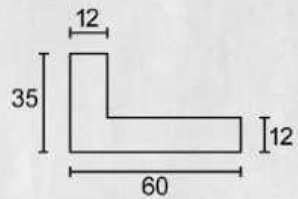

Art. L 35x60

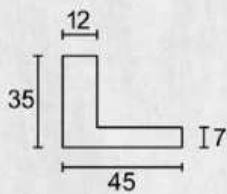

Art. L 35x45
D 12x7

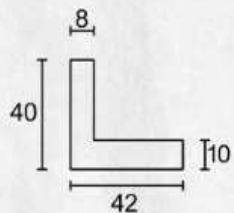

Art. L 40x40
NOCE MASS.

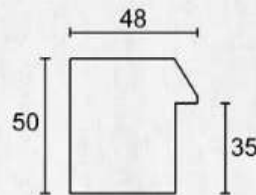

Art. PS 48x50

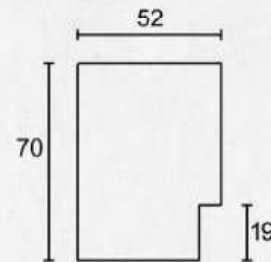

Art. 140/52x70

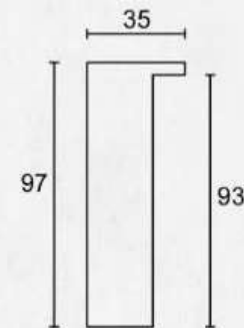

Art. 140/35x97



L 35x60

L 35x45
D12x7

L 40x40
NOCE
MASS.

PS
48x50

140/
52x70

140/
35x97

140/
25x50

140/
12x40

LISTELLO
100x15

LISTELLO
80x35

LISTELLO
50x35

LISTELLO
50x17

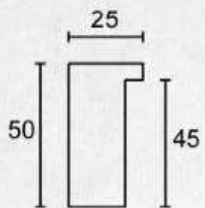

Art. 140/25x50

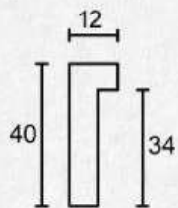

Art. 140/12x40

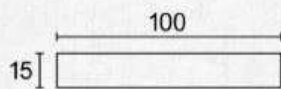

Art. LISTELLO
100x15

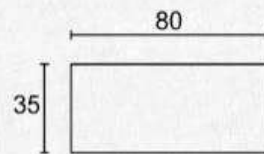

Art. LISTELLO
80x35

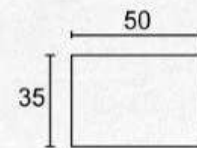

Art. LISTELLO
50x35

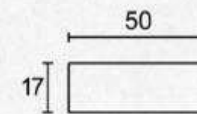

Art. LISTELLO
50x17

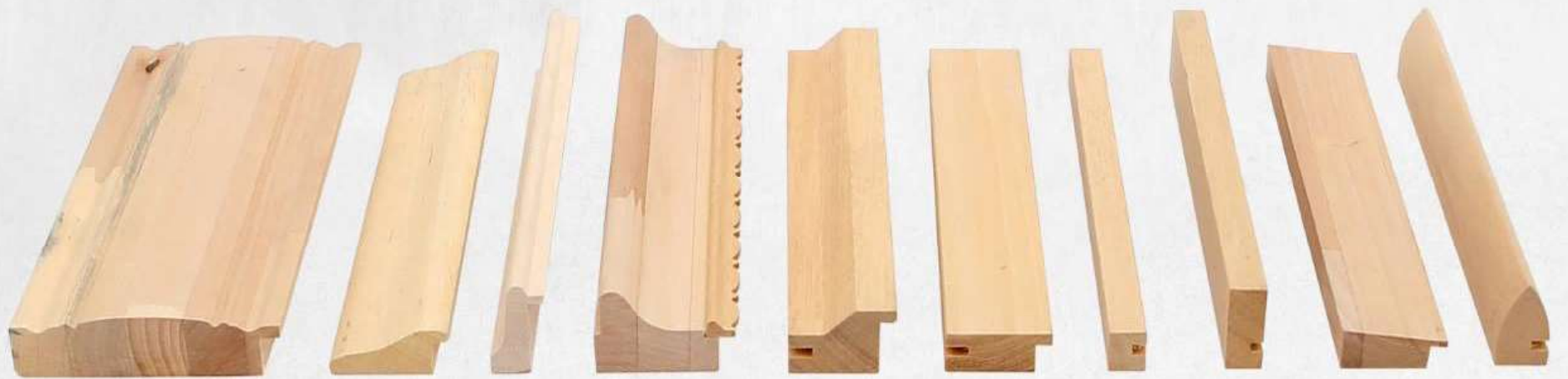
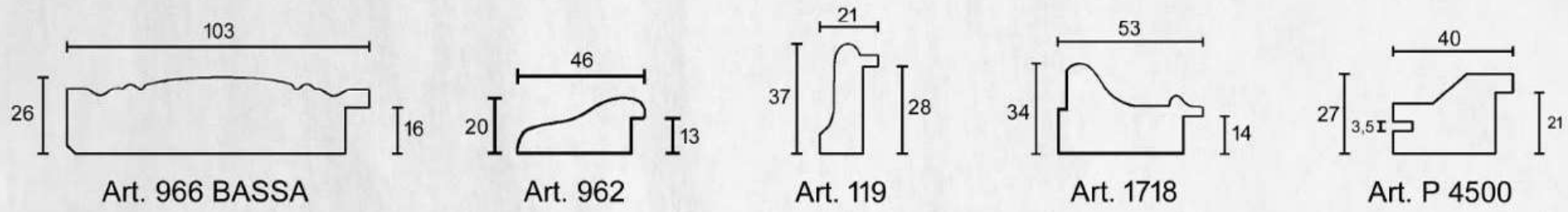

966 BASSA 962 119 1718 P 4500 P 4000 P 1000 14000 84 42700

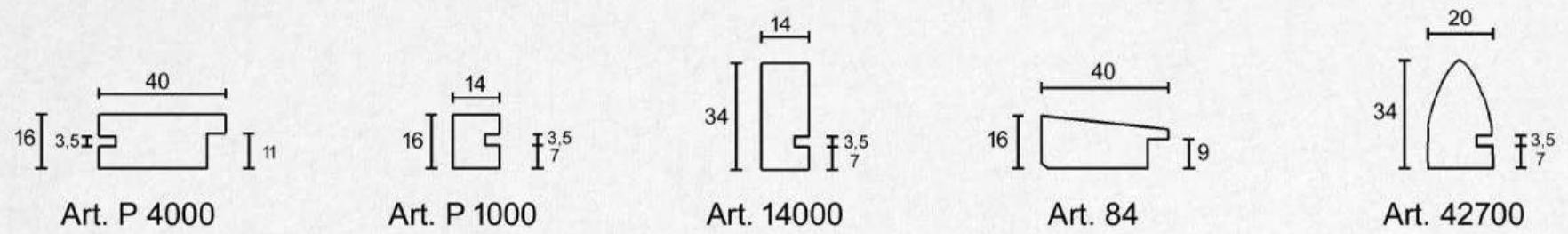

INDICE

art. 67	pag. 49	art. 120	pag. 41	art. 140/30x55 GRE.	pag. 24	art. 204	pag. 49	art. 291	pag. 39
art. 70	pag. 49	art. 121	pag. 33	art. 140/35x80	pag. 32	art. 205	pag. 49	art. 293	pag. 44
art. 74 FLEX	pag. 42	art. 123	pag. 32	art. 140/35x97	pag. 61	art. 216	pag. 53	art. 296 CIL.	pag. 58
art. 74/80 CIL.	pag. 59	art. 124	pag. 32	art. 140/52x70	pag. 61	art. 217	pag. 53	art. 299	pag. 54
art. 75/35 GRECA	pag. 8	art. 125	pag. 16	art. 141	pag. 33	art. 221	pag. 50	art. 300	pag. 54
art. 75/35	pag. 42	art. 128	pag. 16	art. 141/27	pag. 33	art. 223	pag. 54	art. 302	pag. 53
art. 77/30 CIL.	pag. 58	art. 130	pag. 53	art. 142	pag. 32	art. 224	pag. 39	art. 304	pag. 53
art. 77/30 TORT.	pag. 23	art. 131	pag. 34	art. 146 TORT.	pag. 16	art. 224/55	pag. 38	art. 307	pag. 52
art. 77/60 CIL.	pag. 58	art. 131/15 NOCE	pag. 56	art. 146	pag. 32	art. 225	pag. 38	art. 308 ROV.	pag. 58
art. 78	pag. 35	art. 131/15	pag. 34	art. 148/15	pag. 51	art. 226	pag. 51	art. 308	pag. 52
art. 79N BATT. 27	pag. 35	art. 131/30	pag. 34	art. 148/25 B.30	pag. 51	art. 233	pag. 45	art. 309	pag. 42
art. 79N	pag. 35	art. 131/36	pag. 34	art. 148/25	pag. 51	art. 234	pag. 51	art. 310	pag. 39
art. 83 FLEX	pag. 24	art. 131/51	pag. 34	art. 149	pag. 38	art. 240	pag. 49	art. 320	pag. 39
art. 83	pag. 35	art. 131/60x25	pag. 34	art. 154	pag. 31	art. 241	pag. 49	art. 327	pag. 50
art. 84	pag. 62	art. 131/60x27	pag. 37	art. 154/40	pag. 31	art. 244	pag. 47	art. 328	pag. 38
art. 100/25 CIL.	pag. 59	art. 131/66	pag. 34	art. 154/50 ALTA	pag. 31	art. 245	pag. 41	art. 330	pag. 38
art. 100/30 CIL.	pag. 59	art. 135	pag. 51	art. 154/50	pag. 31	art. 245/20	pag. 41	art. 331	pag. 38
art. 100/40 CIL.	pag. 59	art. 136	pag. 54	art. 156/30	pag. 53	art. 246	pag. 52	art. 332	pag. 39
art. 100/40	pag. 41	art. 136/30	pag. 54	art. 160	pag. 23	art. 251	pag. 25	art. 335	pag. 49
art. 100/60	pag. 40	art. 137 ALTA	pag. 54	art. 162	pag. 49	art. 252 ROV.	pag. 59	art. 336	pag. 49
art. 100/63 CIL.	pag. 59	art. 137	pag. 54	art. 164	pag. 34	art. 252	pag. 41	art. 353	pag. 8
art. 101 GOYA	pag. 45	art. 138	pag. 51	art. 167 ROVERE	pag. 56	art. 260	pag. 53	art. 355	pag. 40
art. 101	pag. 45	art. 138/20	pag. 51	art. 167	pag. 34	art. 261	pag. 53	art. 371	pag. 44
art. 101/30	pag. 45	art. 138/25	pag. 51	art. 167/20	pag. 34	art. 262	pag. 53	art. 371/30	pag. 44
art. 102	pag. 45	art. 139	pag. 44	art. 168	pag. 36	art. 263	pag. 53	art. 379	pag. 43
art. 102/20	pag. 45	art. 140 ROVERE	pag. 56	art. 169	pag. 35	art. 267 GUILL.	pag. 23	art. 380 W	pag. 7
art. 102 T	pag. 45	art. 140	pag. 33	art. 170 B.30	pag. 35	art. 270	pag. 5	art. 390	pag. 43
art. 103 A	pag. 45	art. 140/7x22	pag. 33	art. 170	pag. 35	art. 271	pag. 49	art. 398	pag. 51
art. 103 GRECA	pag. 16	art. 140/8x35	pag. 33	art. 171	pag. 35	art. 273 CILIEGIO	pag. 58	art. 401	pag. 38
art. 103	pag. 45	art. 140/10x40	pag. 32	art. 172	pag. 42	art. 273	pag. 46	art. 402	pag. 38
art. 103/30	pag. 45	art. 140/12x40	pag. 61	art. 174	pag. 36	art. 275	pag. 45	art. 403	pag. 40
art. 104 T ALTA	pag. 45	art. 140/13x25 ROV.	pag. 56	art. 176	pag. 21	art. 276/35	pag. 37	art. 404	pag. 53
art. 104	pag. 45	art. 140/13x34 ROV.	pag. 56	art. 183	pag. 35	art. 276/55 ROV.	pag. 57	art. 407	pag. 10
art. 105 G	pag. 46	art. 140/13x34	pag. 33	art. 184	pag. 34	art. 276/60	pag. 37	art. 409	pag. 10
art. 105	pag. 46	art. 140/15x47 D10 TULIP.	pag. 56	art. 185	pag. 33	art. 276/80 CIL.	pag. 57	art. 410	pag. 40
art. 107	pag. 42	art. 140/20x28 GRE.	pag. 24	art. 190	pag. 23	art. 276/80	pag. 37	art. 413	pag. 31
art. 108	pag. 37	art. 140/20x40	pag. 33	art. 191	pag. 35	art. 276/81 ROV.	pag. 57	art. 415	pag. 47
art. 111	pag. 41	art. 140/20x47 TULIPIER	pag. 56	art. 192	pag. 37	art. 277 CILIEGIO	pag. 57	art. 415/48	pag. 47
art. 111/30	pag. 41	art. 140/20x50	pag. 33	art. 194	pag. 53	art. 277 ROVERE	pag. 57	art. 419	pag. 41
art. 113	pag. 31	art. 140/20x55	pag. 33	art. 195 ROVERE	pag. 56	art. 277	pag. 37	art. 423	pag. 41
art. 114	pag. 45	art. 140/20x63 CIL.	pag. 56	art. 195	pag. 32	art. 280	pag. 5	art. 424	pag. 41
art. 115	pag. 32	art. 140/25x35	pag. 33	art. 196	pag. 50	art. 281	pag. 52	art. 425	pag. 5
art. 116 CIL.	pag. 56	art. 140/25x50 GRE.	pag. 24	art. 197	pag. 50	art. 282	pag. 52	art. 430	pag. 49
art. 116	pag. 32	art. 140/25x50	pag. 61	art. 201	pag. 47	art. 283	pag. 52	art. 434	pag. 9
art. 119	pag. 62	art. 140/30 CILIEGIO	pag. 56	art. 201 B	pag. 47	art. 288 CIL.	pag. 58	art. 435	pag. 9
		art. 140/30 FAGGIO	pag. 56	art. 202	pag. 44	art. 288/55 CIL.	pag. 58	art. 437	pag. 54
		art. 140/30 ROVERE	pag. 56	art. 202 N	pag. 44	art. 288/55	pag. 52	art. 445	pag. 18
		art. 140/30	pag. 33	art. 203	pag. 53	art. 290	pag. 39		

art. 450	pag. 43	art. 601	pag. 7	art. 667	pag. 22	art. 720 B	pag. 15	art. 810/20	pag. 21
art. 469	pag. 10	art. 603	pag. 15	art. 669	pag. 6	art. 722	pag. 15	art. 810/30	pag. 21
art. 470	pag. 22	art. 603/15	pag. 15	art. 670	pag. 23	art. 723	pag. 13	art. 810/90	pag. 21
art. 480	pag. 22	art. 603/20	pag. 15	art. 671 ALTA	pag. 4	art. 725	pag. 25	art. 812	pag. 16
art. 483 ALTA	pag. 40	art. 603/25	pag. 15	art. 671	pag. 4	art. 725/60 LISCIA	pag. 25	art. 819	pag. 1
art. 483	pag. 40	art. 603/30 ALTA	pag. 15	art. 672 ALTA	pag. 4	art. 725/60	pag. 25	art. 820	pag. 1
art. 484	pag. 40	art. 608	pag. 15	art. 672	pag. 4	art. 726 ALTA	pag. 9	art. 821	pag. 1
art. 490	pag. 46	art. 610	pag. 16	art. 673 CIL.	pag. 58	art. 726	pag. 9	art. 822	pag. 1
art. 491	pag. 46	art. 613	pag. 17	art. 673	pag. 19	art. 730	pag. 54	art. 824	pag. 25
art. 500	pag. 8	art. 614	pag. 17	art. 677	pag. 7	art. 731 D	pag. 54	art. 827	pag. 10
art. 503/40 CIL.	pag. 59	art. 615	pag. 22	art. 678	pag. 19	art. 731	pag. 54	art. 828	pag. 10
art. 503/40	pag. 51	art. 616	pag. 16	art. 680	pag. 23	art. 732	pag. 15	art. 829	pag. 10
art. 505	pag. 19	art. 617	pag. 17	art. 681	pag. 19	art. 733	pag. 15	art. 831	pag. 48
art. 505 R ALTA	pag. 19	art. 618	pag. 8	art. 682	pag. 19	art. 734	pag. 15	art. 832	pag. 48
art. 505 R GUILL.	pag. 19	art. 623	pag. 18	art. 683	pag. 19	art. 735	pag. 17	art. 835	pag. 7
art. 505 R	pag. 19	art. 623/30	pag. 18	art. 685	pag. 6	art. 738	pag. 15	art. 841	pag. 48
art. 505/35 GUILL.	pag. 19	art. 626	pag. 16	art. 686	pag. 1	art. 743	pag. 8	art. 842	pag. 16
art. 505/35	pag. 19	art. 627	pag. 17	art. 687	pag. 6	art. 743 P	pag. 8	art. 843	pag. 16
art. 507	pag. 42	art. 628	pag. 7	art. 688	pag. 17	art. 744	pag. 8	art. 845	pag. 1
art. 514	pag. 46	art. 631	pag. 16	art. 689	pag. 16	art. 745	pag. 5	art. 846	pag. 4
art. 514/30	pag. 46	art. 632	pag. 16	art. 690	pag. 11	art. 746	pag. 14	art. 850	pag. 9
art. 515	pag. 47	art. 633	pag. 16	art. 691	pag. 21	art. 748	pag. 14	art. 860	pag. 43
art. 521	pag. 52	art. 637	pag. 9	art. 692	pag. 21	art. 750	pag. 43	art. 862	pag. 17
art. 522	pag. 44	art. 638 DECO	pag. 13	art. 693	pag. 21	art. 755	pag. 13	art. 871	pag. 7
art. 524	pag. 41	art. 638 MOD.	pag. 13	art. 694	pag. 8	art. 761	pag. 13	art. 872 CIL.	pag. 59
art. 526	pag. 50	art. 642	pag. 16	art. 695 LISCIA	pag. 43	art. 765	pag. 13	art. 872	pag. 42
art. 527	pag. 50	art. 644	pag. 18	art. 696/20	pag. 10	art. 771	pag. 23	art. 872 ROV.	pag. 59
art. 531	pag. 46	art. 645	pag. 8	art. 698	pag. 9	art. 775	pag. 13	art. 873 CIL.	pag. 59
art. 535	pag. 8	art. 646	pag. 18	art. 699	pag. 2	art. 776	pag. 50	art. 873 ROV.	pag. 59
art. 550	pag. 11	art. 649	pag. 17	art. 700	pag. 14	art. 776 ROV.	pag. 56	art. 873	pag. 42
art. 555	pag. 11	art. 649 SPECIAL	pag. 17	art. 700/25	pag. 14	art. 777	pag. 52	art. 874	pag. 42
art. 560	pag. 11	art. 652	pag. 16	art. 701	pag. 14	art. 778	pag. 20	art. 880	pag. 12
art. 560/30	pag. 11	art. 653	pag. 22	art. 701/25	pag. 14	art. 780	pag. 5	art. 880 SPAGNA	pag. 12
art. 562	pag. 17	art. 654	pag. 9	art. 701/30	pag. 14	art. 787	pag. 52	art. 886	pag. 12
art. 570 ALTA	pag. 11	art. 655	pag. 5	art. 702	pag. 14	art. 793	pag. 13	art. 887	pag. 12
art. 570	pag. 11	art. 656	pag. 5	art. 702 R	pag. 14	art. 794	pag. 13	art. 888	pag. 12
art. 571	pag. 4	art. 657	pag. 18	art. 703	pag. 14	art. 796	pag. 1	art. 889	pag. 12
art. 572	pag. 4	art. 657/10	pag. 18	art. 706	pag. 14	art. 799	pag. 2	art. 889/40	pag. 12
art. 575	pag. 11	art. 657/20	pag. 18	art. 707	pag. 13	art. 800	pag. 6	art. 890	pag. 12
art. 580 ALTA	pag. 11	art. 657/30	pag. 18	art. 711	pag. 14	art. 804	pag. 20	art. 894	pag. 32
art. 580	pag. 11	art. 657/40	pag. 18	art. 713	pag. 14	art. 806	pag. 20	art. 897	pag. 2
art. 590	pag. 11	art. 657/50	pag. 18	art. 714	pag. 13	art. 807	pag. 20	art. 898	pag. 2
art. 591	pag. 18	art. 658	pag. 19	art. 715	pag. 13	art. 808	pag. 22	art. 899	pag. 2
art. 592	pag. 18	art. 660	pag. 6	art. 716	pag. 14	art. 809	pag. 20	art. 900	pag. 21
art. 594	pag. 17	art. 662	pag. 7	art. 717	pag. 22	art. 809/35	pag. 20	art. 902 LUNGO	pag. 20
art. 596	pag. 17	art. 663	pag. 7	art. 718	pag. 5	art. 809/55	pag. 20	art. 902 TRASV.	pag. 20
		art. 664	pag. 8	art. 719	pag. 5	art. 810	pag. 21	art. 904	pag. 21
		art. 665	pag. 22	art. 720	pag. 15	art. 810/15	pag. 21	art. 905	pag. 21

art. 906/30	pag. 1	art. 997	pag. 48	art. D 10	pag. 55	art. P 15X20 CIL.	pag. 60	art. P 110	pag. 27
art. 907	pag. 12	art. 998	pag. 48	art. D 15	pag. 55	art. P 15X20 NOCE	pag. 60	art. P 110X25	pag. 27
art. 909 BASE	pag. 32	art. 999	pag. 9	art. D 20	pag. 55	art. P 16 GOYA	pag. 44	art. P 1000	pag. 62
art. 909 LIST.	pag. 3	art. 1013	pag. 46	art. D 25	pag. 55	art. P 16	pag. 44	art. P 4000	pag. 62
art. 909 LIST. B	pag. 3	art. 1014	pag. 46	art. D 30	pag. 55	art. P 18 ROV.	pag. 60	art. P 4500	pag. 62
art. 910	pag. 12	art. 1072 CIL.B.CO OLD	pag. 59	art. D 45	pag. 55	art. P 20 APR.	pag. 24	art. PASS 200	pag. 48
art. 910/40	pag. 12	art. 1073	pag. 59	art. DG 15	pag. 55	art. P 20 FLEX	pag. 24	art. PG 2/40	pag. 31
art. 912	pag.41	art. 1080	pag. 6	art. DG 20	pag. 55	art. P 20	pag. 28	art. PG 10	pag. 29
art. 916	pag.7	art. 1084	pag. 50	art. DG 20 B	pag. 55	art. P 20X18 TIGLIO	pag. 28	art. PG 15	pag. 29
art. 920 ALTA	pag. 9	art. 1101	pag. 48	art. DG 30	pag. 55	art. P 20X20	pag. 27	art. PG 20	pag. 29
art. 920	pag. 9	art. 1102	pag. 48	art. DG 45	pag. 55	art. P 20X21 CIL.	pag. 60	art. PG 22	pag. 30
art. 921	pag. 50	art. 1103	pag. 48	art. DS 10	pag. 55	art. P 25	pag. 28	art. PG 25 B	pag. 29
art. 922	pag. 40	art. 1104	pag. 50	art. DS 15	pag. 55	art. P 25X20 ROV.	pag. 60	art. PG 30	pag. 29
art. 923	pag. 48	art. 1163	pag. 36	art. DS 20	pag. 55	art. P 26	pag. 44	art. PG 30 B	pag. 29
art. 925	pag. 22	art. 1164	pag. 36	art. DS 25	pag. 55	art. P 30 APR.	pag. 24	art. PG 34	pag. 30
art. 926	pag. 47	art. 1166	pag. 37	art. DS 30	pag. 55	art. P 30	pag. 28	art. PG 35 B	pag. 29
art. 927	pag. 47	art. 1167	pag. 37	art. L 30X30 4X8	pag. 25	art. P 30X20 ALDER	pag. 60	art. PG 40	pag. 29
art. 927 RUS.	pag. 24	art. 1201	pag. 13	art. L 30X30 4X8 ROV.	pag. 25	art. P 30X20 CIL.	pag. 60	art. PG 40B	pag. 29
art. 928	pag. 16	art. 1220	pag. 6	art. L 34X45 D 12X7	pag. 61	art. P 30X20 NOCE	pag. 60	art. PG 41	pag. 30
art. 934	pag. 51	art. 1221	pag. 22	art. L 35X45	pag. 25	art. P 30X20 ROV.	pag. 60	art. PG 44	pag. 30
art. 937	pag. 3	art. 1601	pag. 40	art. L 35X60	pag. 61	art. P 30X28 GRE	pag. 24	art. PG 45	pag. 45
art. 938	pag. 32	art. 1672	pag. 4	art. L 40X40 NOCE MASS.	pag. 61	art. P 30X30 D15	pag. 27	art. PG 45 B	pag. 29
art. 940/50	pag. 49	art. 1696	pag. 10	art. L 40X40 ROV.	pag. 25	art. P 30X30	pag. 27	art. PG 46	pag. 30
art. 944	pag. 46	art. 1697	pag. 10	art. L 45X50	pag. 25	art. P 34X35	pag. 31	art. PG 50	pag. 29
art. 945	pag. 12	art. 1718	pag. 62	art. L 45X65	pag. 25	art. P 35X25	pag. 27	art. PG 51	pag. 30
art. 947	pag. 22	art. 1738	pag. 23	art. LISTELLO 10X10	pag. 26	art. P 36	pag. 44	art. PG 55	pag. 29
art. 948	pag. 22	art. 1897	pag. 2	art. LISTELLO 15X10	pag. 26	art. P 40 FLEX	pag. 24	art. PIP G	pag. 55
art. 950	pag. 11	art. 1898	pag. 2	art. LIST. 18X15 AYOUS	pag. 26	art. P 40	pag. 28	art. PIP	pag. 55
art. 955	pag. 18	art. 1899	pag. 2	art. LISTELLO 20X10	pag. 26	art. P 40X18 TIGLIO	pag. 28	art. PIP 702	pag. 14
art. 956	pag. 17	art. 2050	pag. 39	art. LISTELLO 30X15	pag. 26	art. P 40X20 CIL.	pag. 60	art. PR 25	pag. 23
art. 960	pag. 3	art. 2052	pag. 38	art. LISTELLO 45X45	pag. 26	art. P 40X20 NOCE	pag. 60	art. PR 45	pag. 23
art. 961	pag. 3	art. 2053 CILIEGIO	pag. 58	art. LISTELLO 50X12	pag. 26	art. P 40X20 ROV	pag. 60	art. PS 21	pag. 30
art. 962	pag. 62	art. 2053	pag. 38	art. LISTELLO 50X15	pag. 26	art. P 45	pag. 28	art. PS 31	pag. 30
art. 963	pag. 3	art. 2054	pag. 39	art. LISTELLO 50X17	pag. 61	art. P 45X35	pag. 27	art. PS 41 APR.	pag. 24
art. 966 BASSA	pag. 62	art. 2055	pag. 39	art. LISTELLO 50X20	pag. 26	art. P 50	pag. 28	art. PS 41	pag. 30
art. 969	pag. 10	art. 3001	pag. 52	art. LISTELLO 50X35	pag. 61	art. P 50X20 ALDER	pag. 57	art. PS 44	pag. 30
art. 971	pag. 36	art. 3002	pag. 38	art. LISTELLO 60X20	pag. 26	art. P 50X20 CIL.	pag. 57	art. PS 45/35	pag. 30
art. 972	pag. 36	art. 3003	pag. 39	art. LISTELLO 60X25	pag. 26	art. P 50X38 GRE.	pag. 24	art. PS 48X50	pag. 61
art. 973	pag. 36	art. 3006	pag. 51	art. LISTELLO 80X15	pag. 26	art. P 55	pag. 28	art. PS 50	pag. 30
art. 976	pag. 1	art. 5020	pag. 28	art. LISTELLO 80X20	pag. 26	art. P 55X25	pag. 27	art. PS 50X11	pag. 30
art. 979	pag. 10	art. 14000	pag. 62	art. LISTELLO 80X35	pag. 61	art. P 56	pag. 27	art. PS 60	pag. 30
art. 981	pag. 3	art. 41030	pag. 49	art. LISTELLO 100X15	pag. 61	art. P 60	pag. 28	art. PS 90	pag. 30
art. 984	pag. 49	art. 41415	pag. 47	art. LISTELLO 100X20	pag. 26	art. P 64X35	pag. 31	art. RIALZO 25	pag. 26
art. 985	pag. 6	art. 42060	pag. 3	art. MULA	pag. 50	art. P 70	pag. 28	art. RIALZO 45	pag. 26
art. 990	pag. 12	art. 42065	pag. 3	art. P 10 CIL.	pag. 60	art. P 90	pag. 28	art. SOLE 5	pag. 36
art. 993	pag. 12	art. 42070	pag. 3	art. P 10	pag. 28	art. P 90X20 CIL.	pag. 57	art. TELAIO DS50	pag. 26
art. 995	pag. 22	art. 42700	pag. 62	art. P 15	pag. 28	art. P 95X25	pag. 27		
art. 996	pag. 47	art. D05	pag. 55	art. P 15X20 ALDER	pag. 60	art. P 100X20 CILIEGINO	pag. 57		



PROVASI LUCA

PRODUZIONE DI ASTE IN LEGNO PER CORNICI

Largo Brugheti, 1/A2 - 20813 BOVISIO MASCIAGO (MB) P.IVA 02519060962

Tel. 0362.571045 - Fax 0362.594376

E-mail: info@provasilucacornici.it Sito internet: www.provasilucacornici.com